Global System for Mobile Communications (GSM) Protocol Analysis and Simulation



818 West Diamond Avenue - Third Floor, Gaithersburg, MD 20878
Phone: (301) 670-4784 Fax: (301) 670-9187 Email: info@gl.com
Website: <https://www.gl.com>

What is GSM ?

- Global System for Mobile (GSM) is a second generation cellular standard developed to cater voice services and data delivery using digital modulation

Based on ETSI standards

- GSM is a digital system with an over-the-air bit rate of 270 kbps. The frequency range is 1,850 to 1,990 MHz (mobile station to base station)
- GSM utilizes the time or frequency division multiple access (TDMA / FDMA) concept
- GSM uses Gaussian minimum shift keying (GMSK)
- GSM specifications follow the stipulations for the bottom three layers (physical, data link, & network layers) of the OSI model

Advantages of GSM over Analog System

- Capacity increases
- Reduced RF transmission power and longer battery life
- International roaming capability
- Better security against fraud (through terminal validation and user authentication)
- Encryption capability for information security and privacy
- Compatibility with ISDN, leading to wider range of services

GSM Specifications

- **GSM 900**

- Mobile to BTS (uplink): 890-915 Mhz
- BTS to Mobile(downlink):935-960 Mhz
- Bandwidth : 2* 25 Mhz

- **GSM 1800**

- Mobile to BTS (uplink): 1710-1785 Mhz
- BTS to Mobile(downlink) 1805-1880 Mhz
- Bandwidth : 2* 75 Mhz
- PCS 1900 or DCS 1900
- The only frequency used in the United States and Canada for GSM

GSM System Architecture

- Network Switching Subsystem (NSS) – Its main components include:
 - Mobile Switching Center (MSC)
 - Home Location Register (HLR)
 - Visitor Location Register (VLR)
 - Authentication Center (AUC)
 - Equipment Identity Register (EIR)
- Base Station Subsystem (BSS) – Its main components include:
 - Base Transceiver Station (BTS)
 - Base Station Controller (BSC)
- Mobile Station (MS) – Its main components include:
 - Mobile Equipment (ME)
 - Subscriber Identity Module (SIM)
- Operation SubSystem (OSS) – Its main components include:
 - Operations and Maintenance Center (OMC)
 - Network Management Center (NMC)
 - Administration Center (ADC)

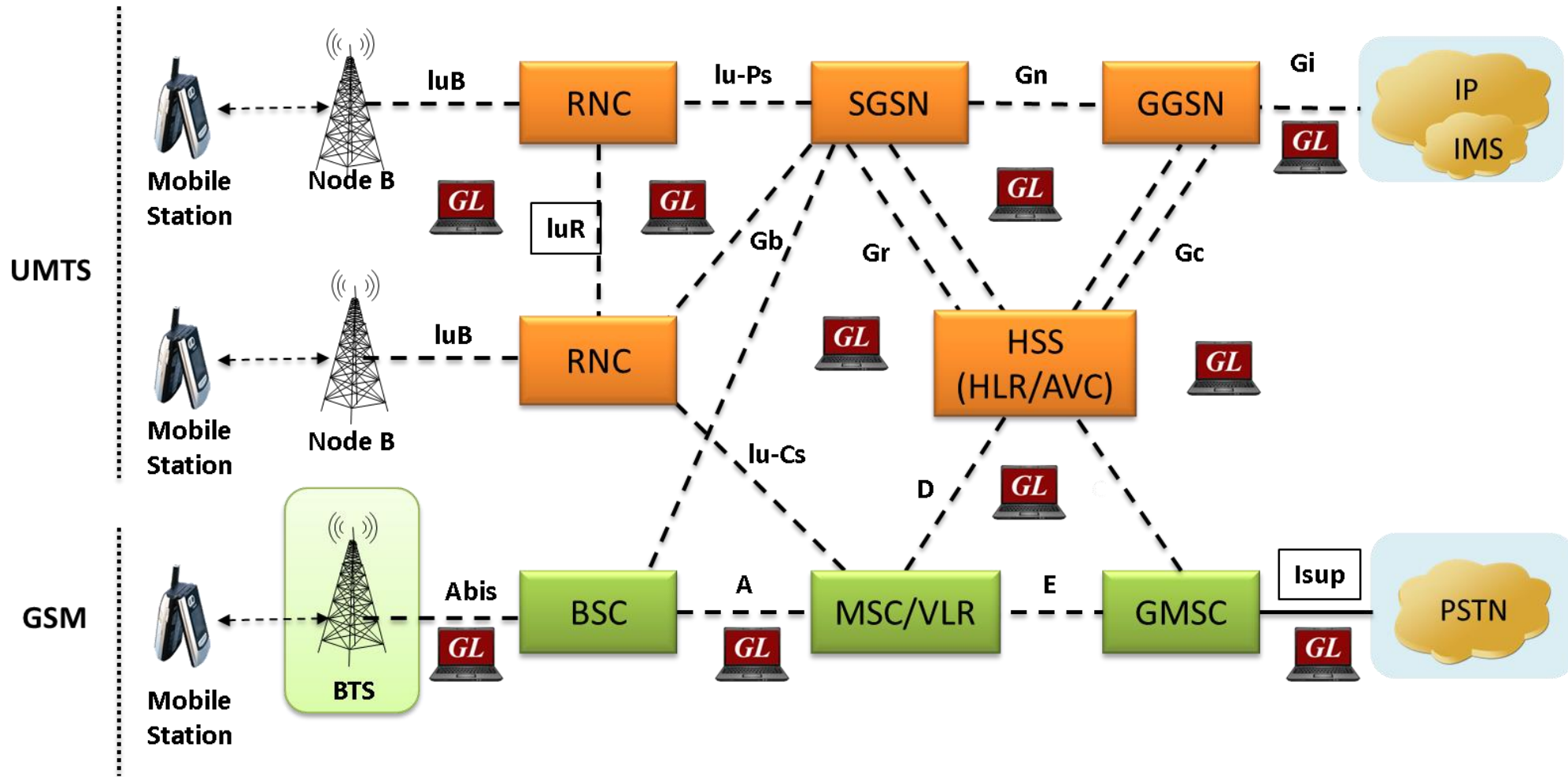

GL's TRAU, GPRS, GSM, UMTS Analyzer
 GL's MAPS™ GSM A, GSM Abis, GSMA over IP, MAP, MAP over IP Emulators

T1 E1 Analyzer Hardware Platforms



**tProbe™ - Portable USB based T1 E1 VF
FXO FXS and Serial Datacom Analyzer**



Quad / Octal T1 E1 PCIe Card



Dual T1 E1 Express (PCIe) Board

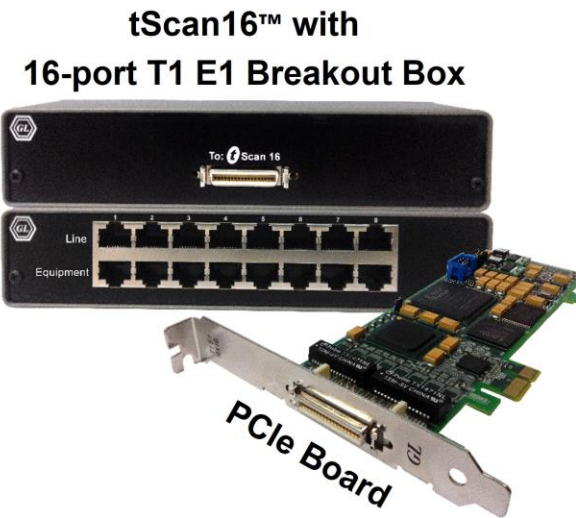

**tScan16™ with
16-port T1 E1 Breakout Box**

PCIe Board

TDM mTOP™ Solutions

mTOP tProbe FXO FXS Dual UTA



1U tProbe with FXO and FXS1



Base Station Subsystem (BSS)

- **Base Transceiver Station (BTS)**
 - Encodes, encrypts, multiplexes, modulates and feeds the RF signals to the antenna.
 - Frequency hopping
 - Communicates with Mobile station and BSC
 - Consists of Transceivers (TRX) units
- **Base Station Controller (BSC)**
 - Manages Radio resources for BTS
 - Assigns Frequency and time slots for all MS's in its area
 - Handles call set up
 - Transcoding and rate adaptation functionality
 - Handover for each MS
 - Radio Power control
 - It communicates with MSC and BTS

Network Switching Subsystem (NSS)

- Carries out switching functions and manages the communications between mobile phones and the PSTN
- Allows mobile phones to communicate with each other
- Includes the following elements –
 - Mobile Switching Center (MSC) –
 - Capable of receiving a short message from a Service Center (SC)
 - Interrogating an HLR for routing information and message waiting data, and delivering the short message to the MSC of the receiving MS
 - Home Location Registers (HLR) –
 - Connection of mobile subscribers and definition of corresponding subscriber data
 - Maintenance of a database of mobile subscribers and corresponding subscriber data
 - Subscription to basic services
 - Registration/deletion of supplementary services
 - Activation/deactivation of supplementary services

Network Switching Subsystem (NSS)

➤ Visitor Location Registers (VLR) –

- Functions for setting up and controlling calls, including supplementary services
- Functions for handling speech path continuity for moving subscribers (handover)
- Functions for updating mobile subscribers' location (location updating and location canceling) in the different location registers
- Functions for updating mobile subscriber data

➤ Authentication Center (AUC) -

- a RANDom number (RAND)
- a Signed RESponse (SRES)
- a Ciphering Key (Kc)
 - generates user specific authentication parameters on request of a VLR authentication parameters used for authentication of mobile terminals and encryption of user data on the air interface within the GSM system

➤ Equipment Identity Register (EIR)

- registers GSM mobile stations and user rights stolen or malfunctioning mobile stations can be locked and sometimes even localized

GSM Signaling Interfaces

- Um - Air interface used for exchanges between a MS and a BSS
- Abis - Abis interface allows control of the radio equipment and radio frequency allocation in the BTS
- A - A interface is between the BSS and the MSC. The A interface manages the allocation of suitable radio resources to the MSs and mobility management
- B - The B interface between the MSC and the VLR uses the MAP/B protocol. Most MSCs are associated with a VLR, making the B interface "internal"
- C - The C interface is between the HLR and a GMSC or a SMS-G. MAP/C protocol over the C interface is used to obtain the routing information required to complete the call
- D - The D interface is between the VLR and HLR, and uses the MAP/D protocol to exchange the data related to the location of the MS and to the management of the subscriber

Interfaces

- E - The E interface interconnects two MSCs. The E interface exchanges data related to handover between the anchor and relay MSCs using the MAP/E protocol
- F - The F interface connects the MSC to the EIR, and uses the MAP/F protocol to verify the status of the IMEI that the MSC has retrieved from the MS
- G - The G interface interconnects two VLRs of different MSCs and uses the MAP/G protocol to transfer subscriber information, during e.g. a location update procedure
- H - The H interface is between the MSC and the SMS-G, and uses the MAP/H protocol to support the transfer of short messages
- I - The I interface (not shown in Figure 1) is the interface between the MSC and the MS. Messages exchanged over the I interface are relayed transparently through the BSS

Comparing GSM layers with OSI model

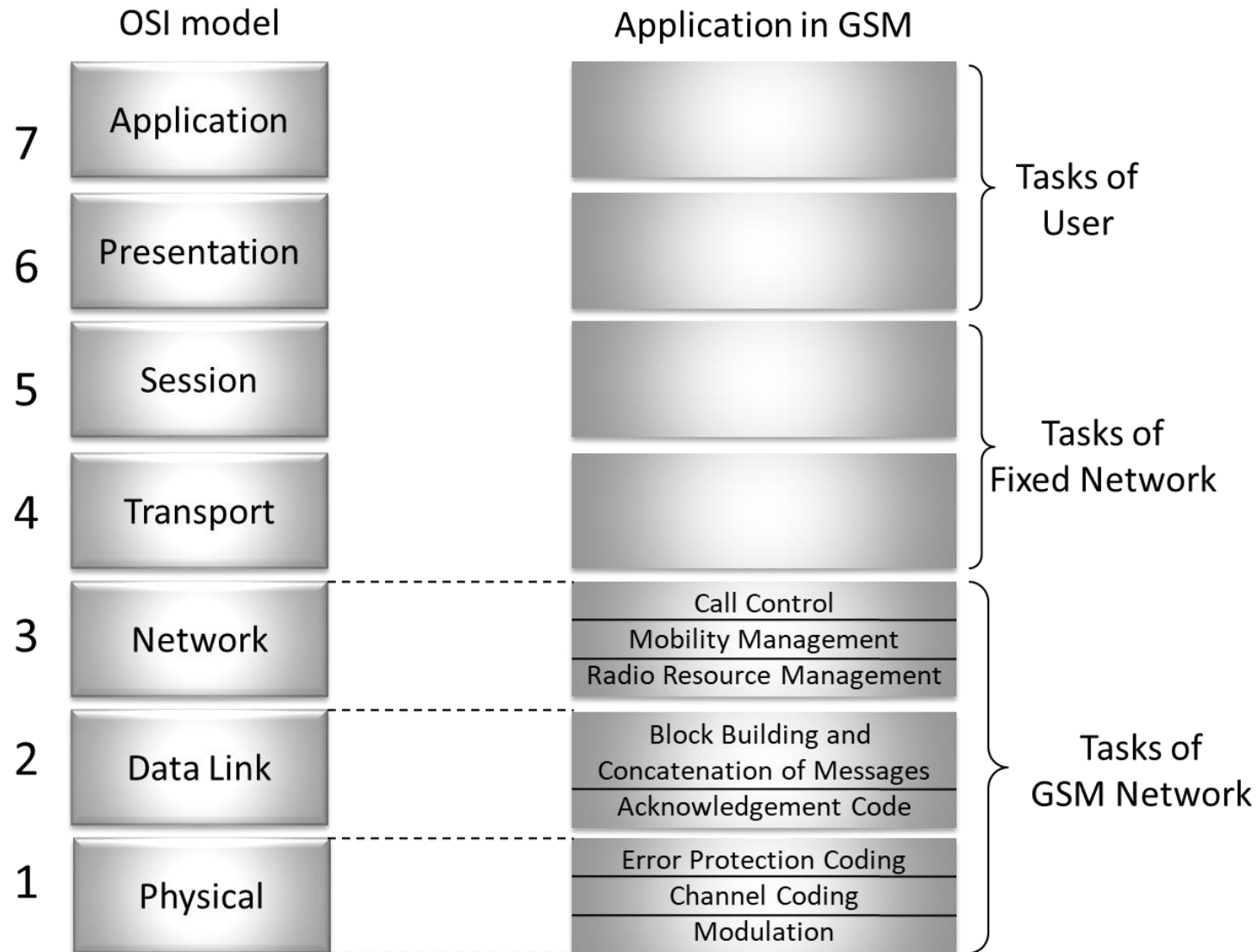

GSM Protocol Layers for Signaling

- CM – Connection Management
- MM – Mobility Management
- RR – Radio Resource Management
- LAPDm – Link Access Protocol D-Channel Modified
- BSSMAP Base Station Subsystem Mobile Application Part

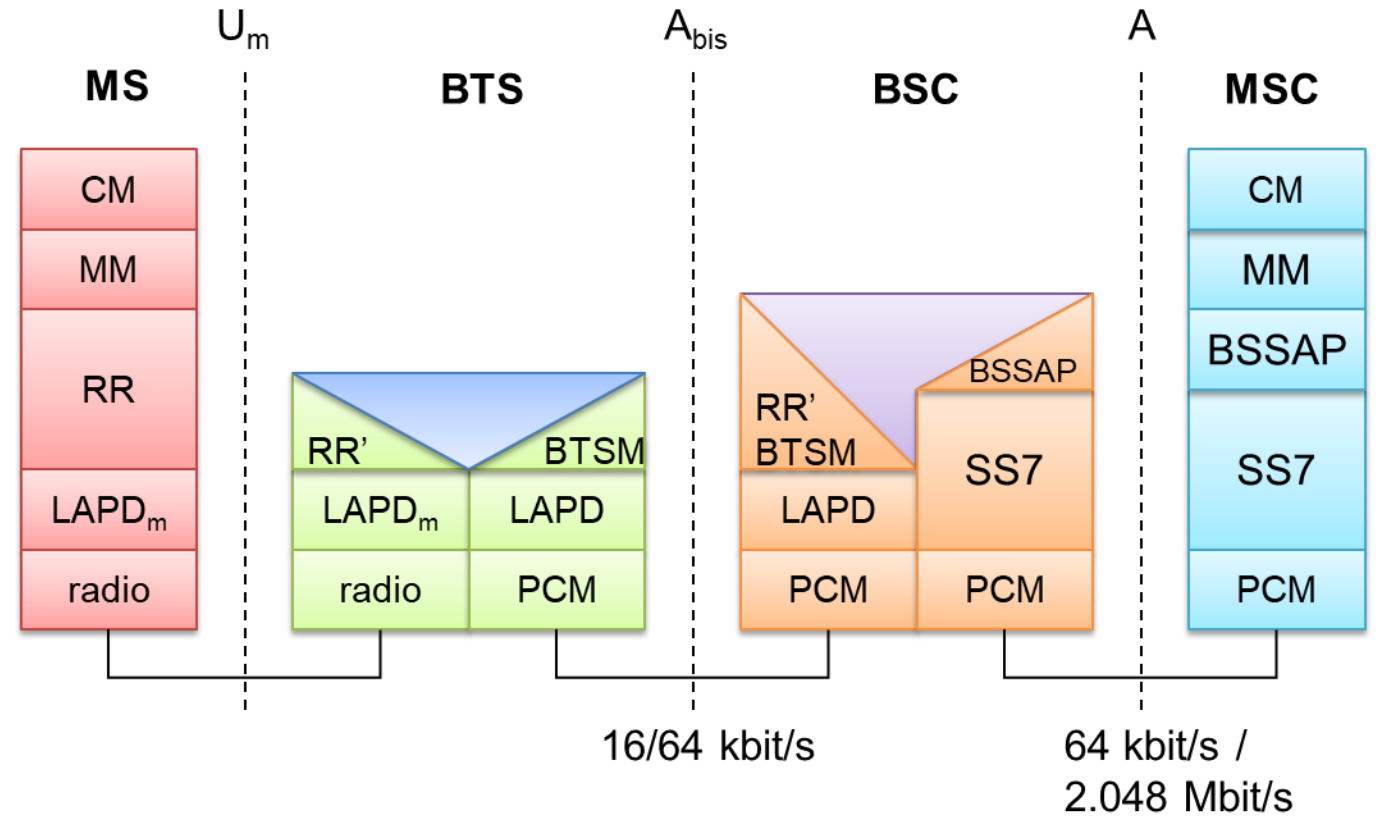

Logical Channels

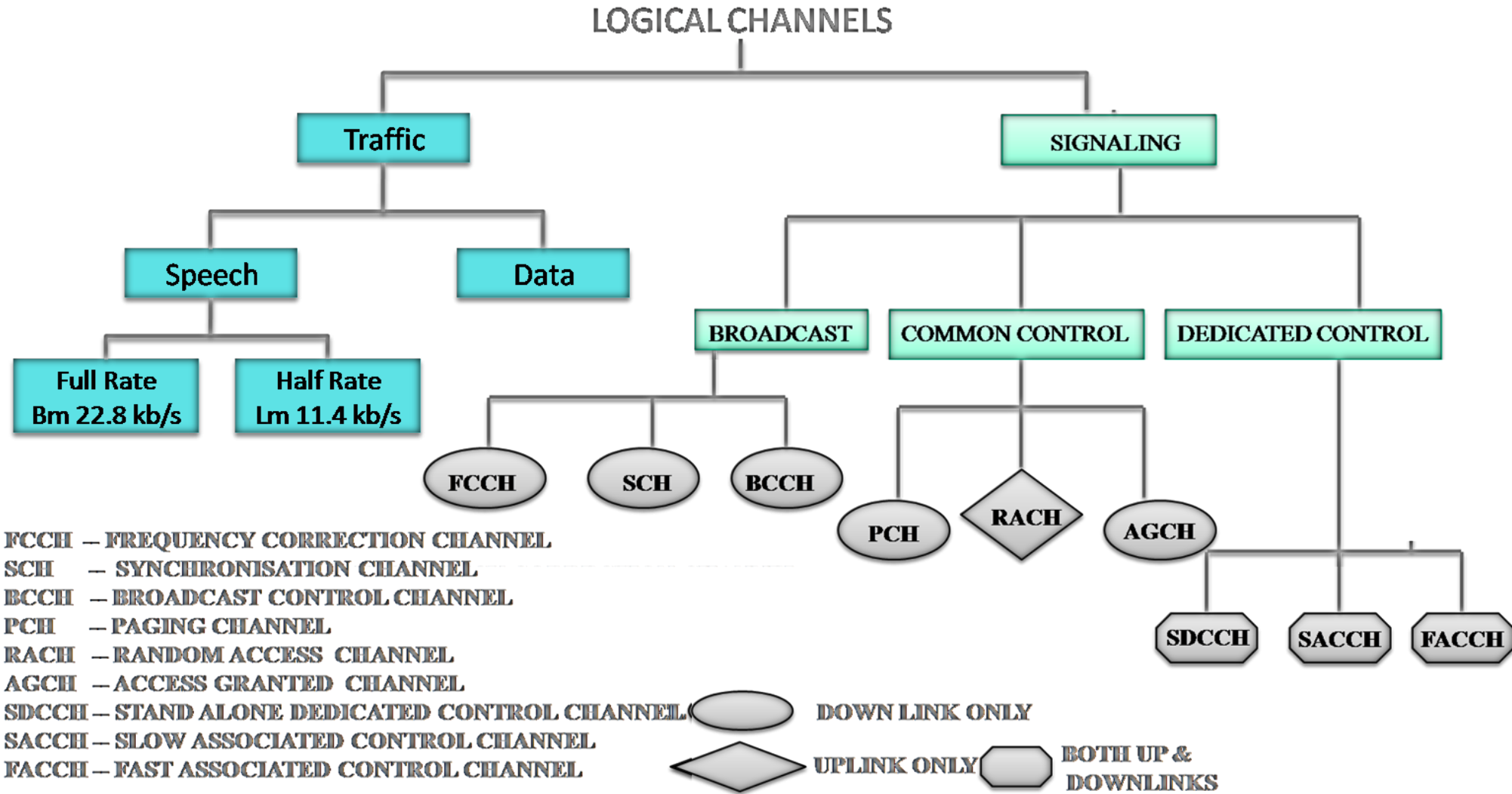

GSM Services

- Tele-services Telecommunication services that enable voice communication, fax transmission via mobile phones
 - Offered services - Mobile telephony, Emergency calling
- Bearer or Data Services Include various data services for information transfer between GSM and other networks like PSTN, ISDN etc. at rates from 300 to 9600 bps
 - Offered services - Short Message Service (SMS), Unified Messaging Services(UMS), Group 3 fax, Voice mailbox, Electronic mail
- Supplementary Service
 - Call related services - Call Waiting, Call Hold, Call Barring, Call Forwarding, Multi Party Call Conferencing, CLIP , CLIR , CUG

GSM Frame Structure

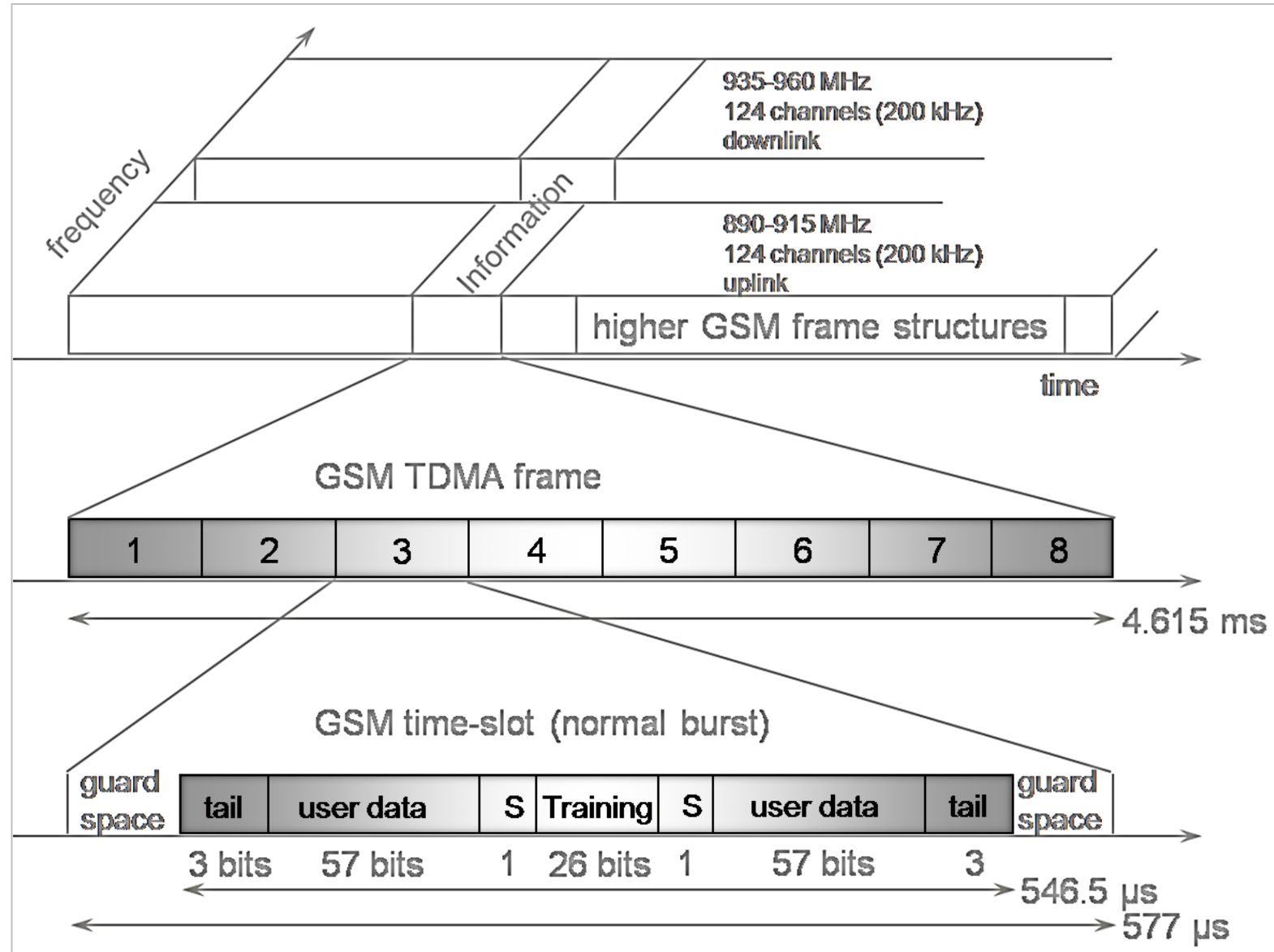

GSM Operation

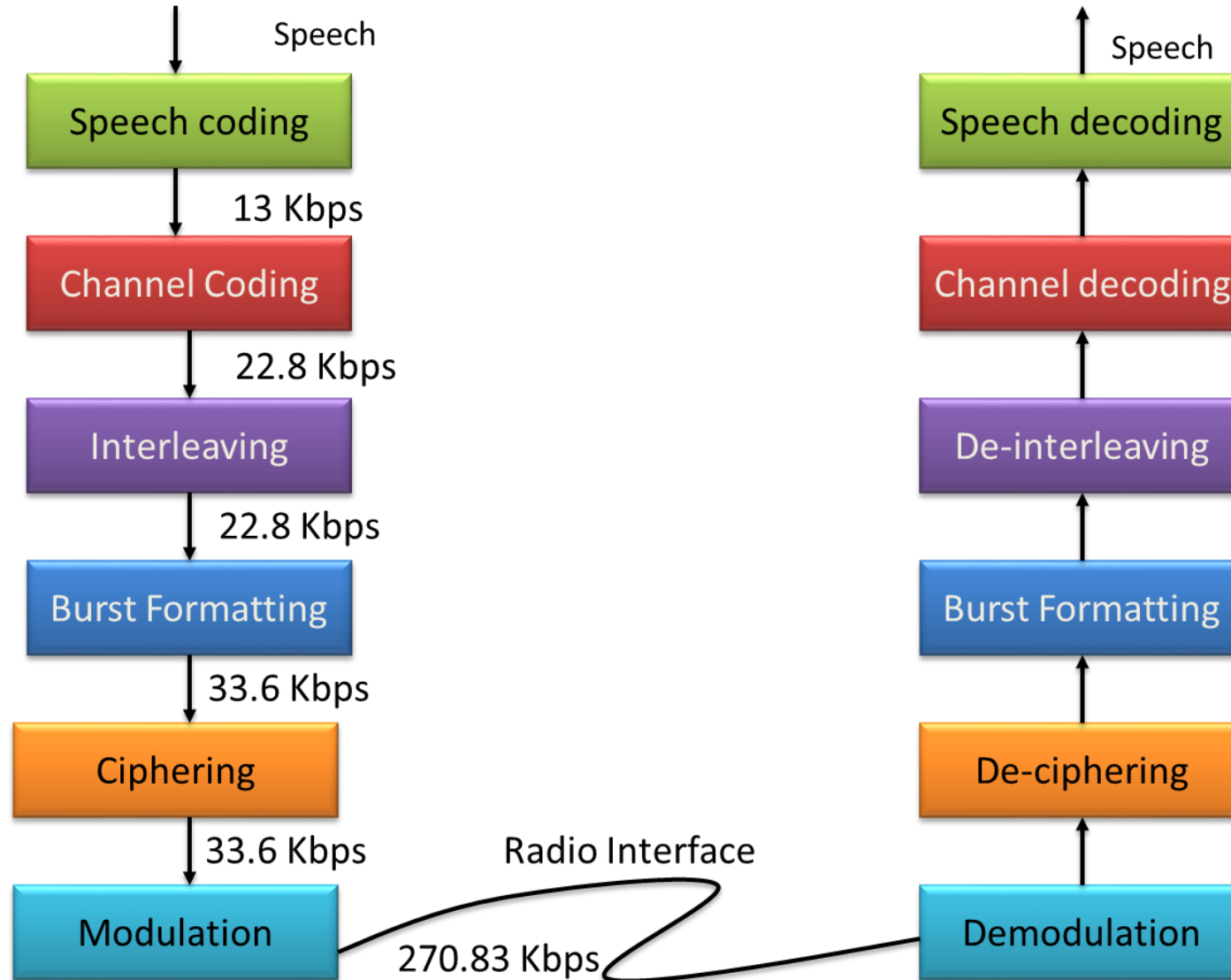

Message Format

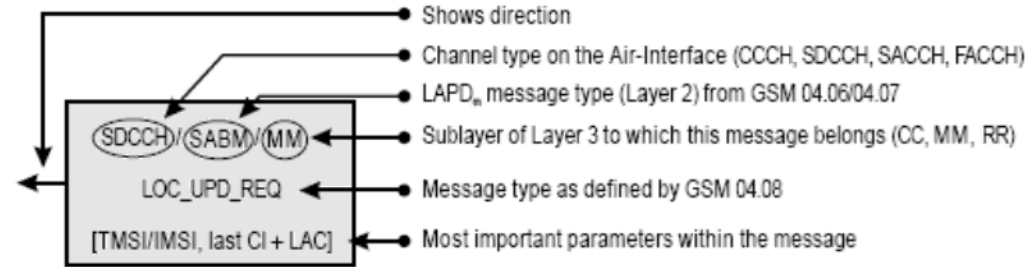

Figure 1.4(a) Format for messages over the Air-interface (LAPD_m, GSM 04.08).

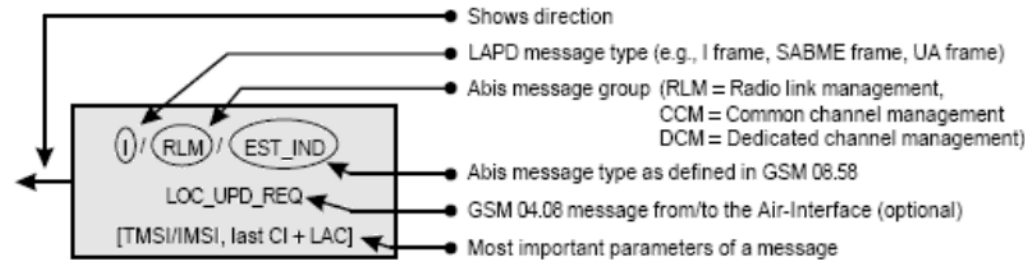

Figure 1.4(b) Format for messages over the Abis-interface (LAPD, GSM 08.58).

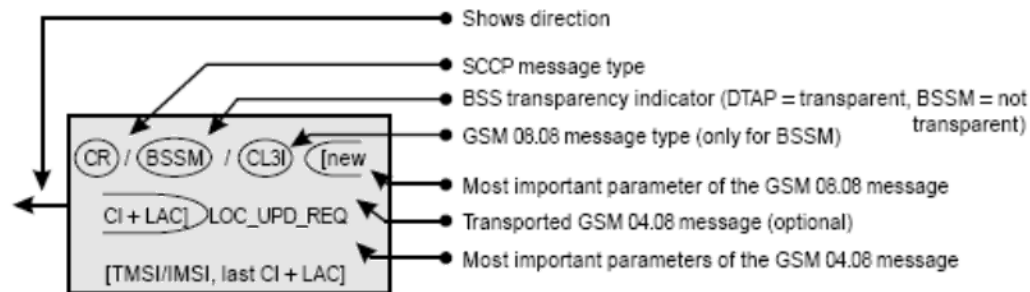

Figure 1.4(c) Format for messages over the A-interface [SS7, signaling connection control part (SCCP), GSM 08.06, GSM 08.08].

Message Format

Figure 1.4(c) Format for messages over the A-interface [SS7, signaling connection control part (SCCP), GSM 08.06, GSM 08.08].

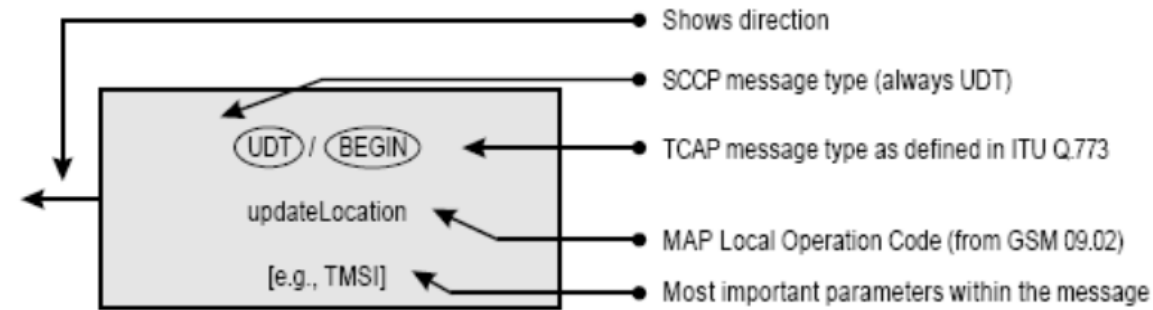

Figure 1.4(d) Format for mobile application part (MAP) messages over all network switching subsystem (NSS) interfaces [SS7, SCCP, transaction capabilities application part (TCAP), MAP].

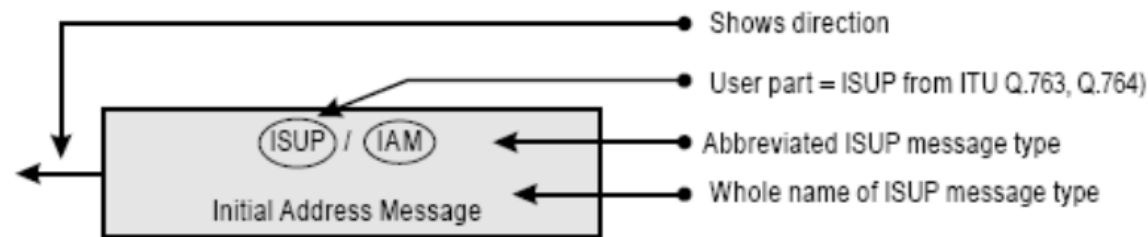
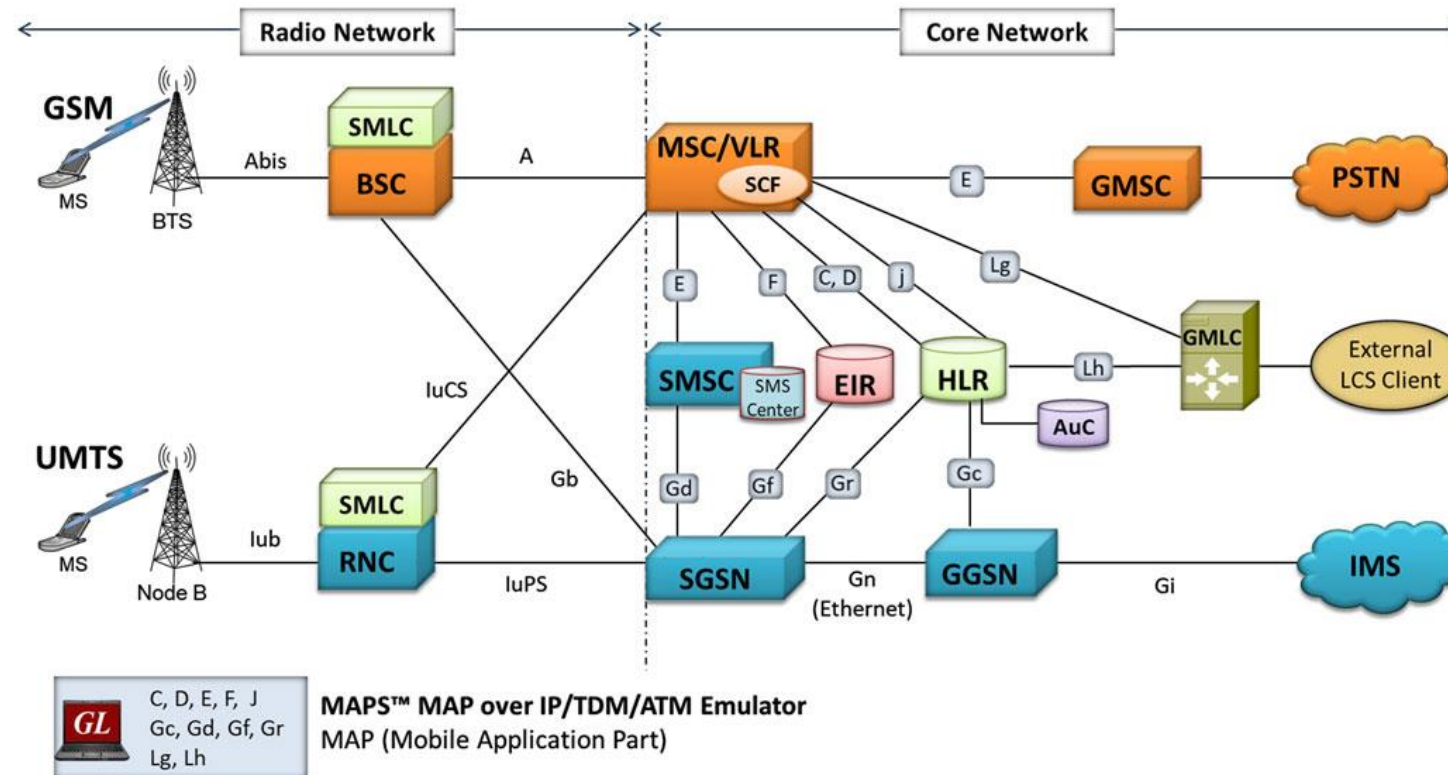

Figure 1.4(e) Format for ISUP messages between MSCs and toward the Integrated Services Digital Network (ISDN) [SS7 and the ISDN user part (ISUP)].

Mobile Application Part (MAP) Signaling for GSM and UMTS Networks

- The components in the MSCs such as HLR, AuC, EIR, and the VLR are interconnected by MAP signaling
- MAP uses Signaling System No. 7 (SS7) as carrier and provide services to mobile phone users such as roaming, call handling, non-interruptive handover, and more



Mobile Application Part (MAP) Signaling

- Some of the GSM/UMTS Circuit Switched interfaces transported over SS7 using MAP signaling are:
 - B -> MSC to VLR
 - C -> MSC to HLR
 - D -> VLR to HLR
 - E -> Inter-MSC handover
 - F -> MSC to EIR
- There are also several GSM/UMTS PS interfaces transported over SS7 using MAP signaling :
 - Gr -> SGSN to HLR
 - Gd -> SGSN to SMS-C
 - Gc -> GGSN to HLR
 - Gf -> SGSN to EIR

Typical Protocol Stack

- The Mobile Application Part (MAP) is the application-layer protocol that resides on top of the SS7 protocol stack, and is carried within Transaction Capabilities Application Part (TCAP) messages

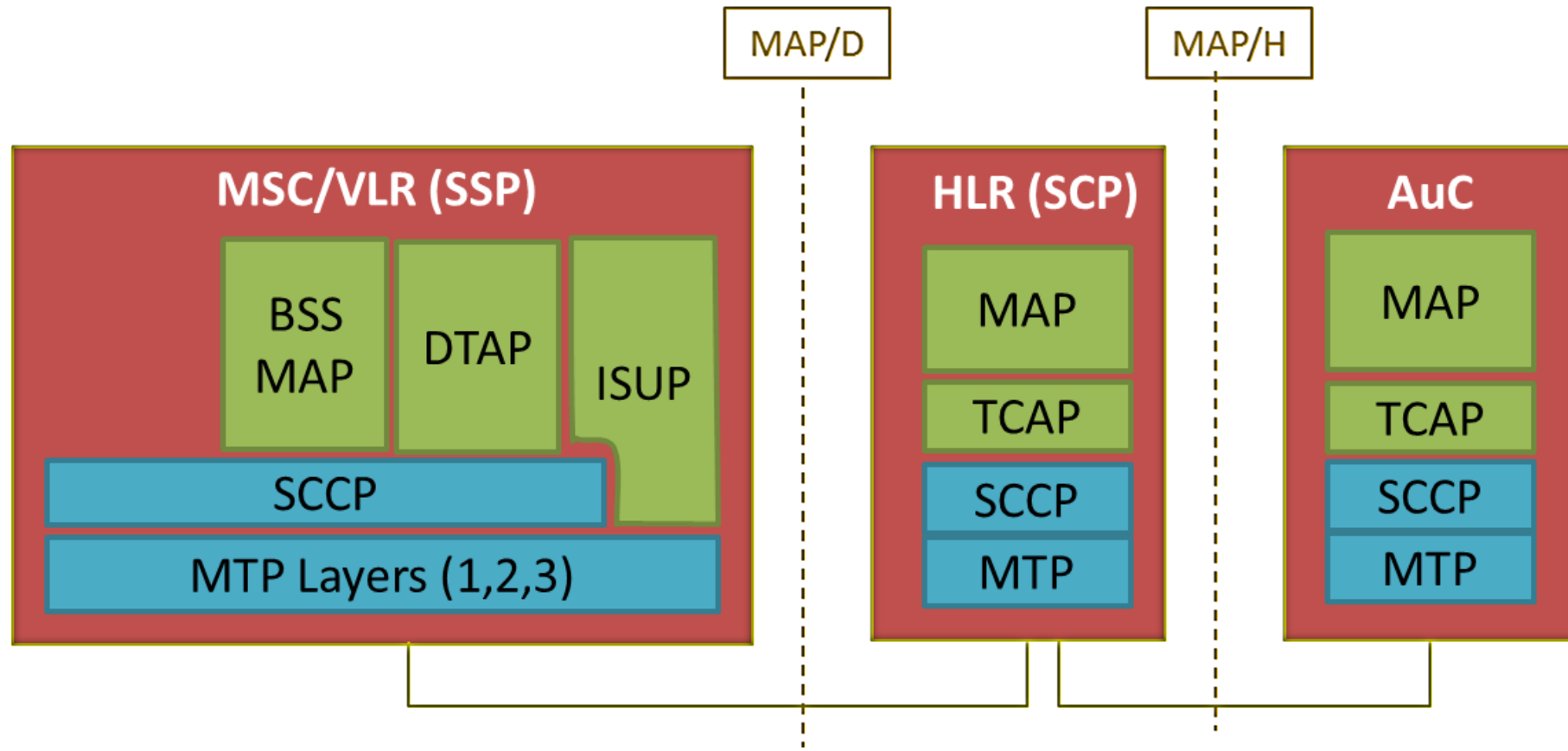

GL's GSM Protocol Analysis and Simulation

GL's GSM Analyzer

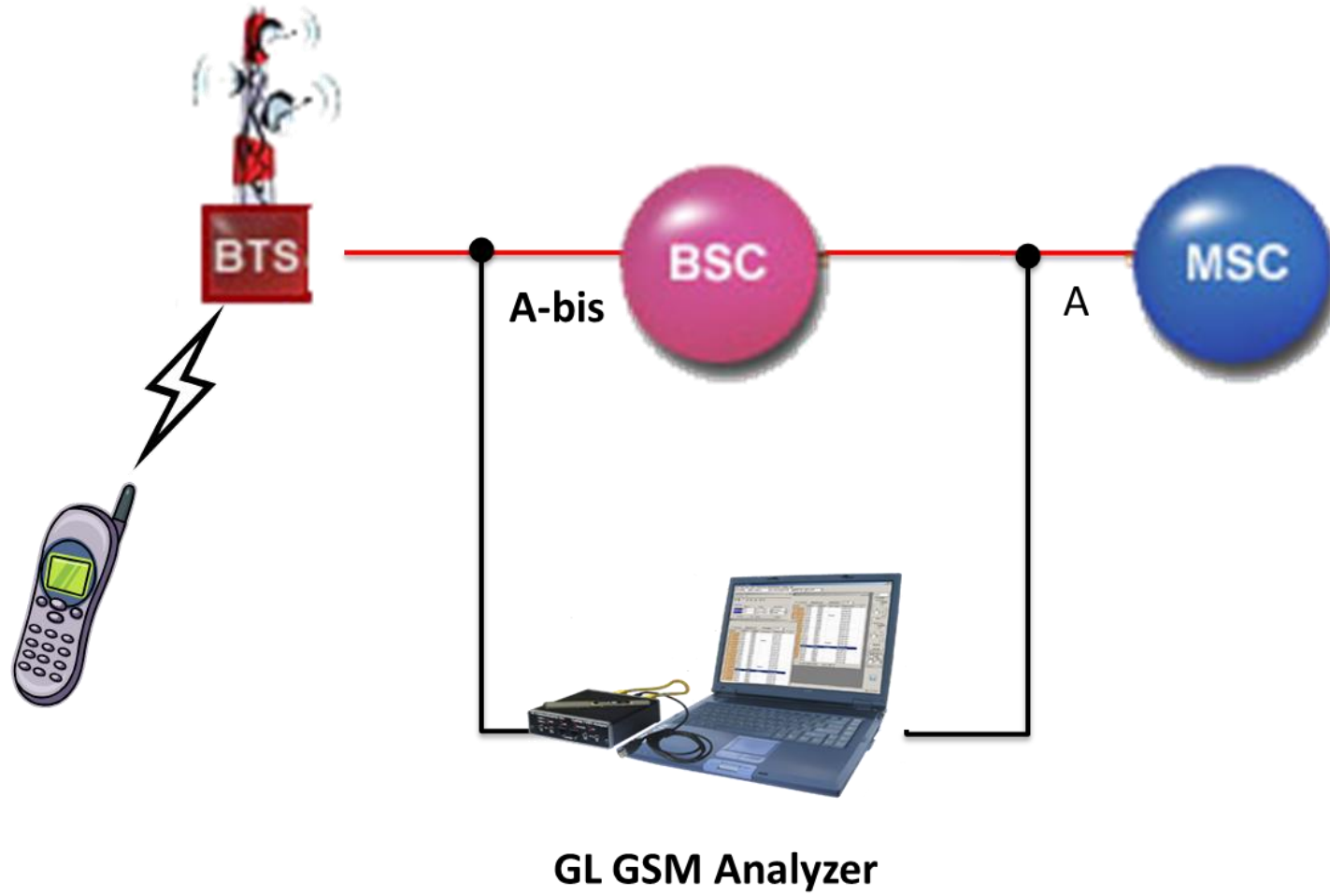

GL's GSM Analyzer

GSM Protocol Analysis A-Interface GSM900 64-bit

File View Capture Statistics Database Call Detail Records Configure Help

0 GoTo

Dev	TSlot	SubCh	Frame#	TIME (Relative)	Len	Error	OPC MTP3	DPC MTP3	Message Type GSM Phase2+	Message Type RR	Message Type MM
✓ 1	23		4	00:00:02.012875	29		2.2.2	1.1.1	CIPHER MODE COMMA...		
✓ 2	23		5	00:00:02.664125	29		1.1.1	2.2.2	CIPHER MODE COMPLE...		
✓ 1	23		6	00:00:03.323875	23		2.2.2	1.1.1			IDENTITY REQ...
✓ 2	23		7	00:00:03.987125	31		1.1.1	2.2.2			IDENTITY RES...
✓ 1	23		8	00:00:04.652875	33		2.2.2	1.1.1			TMSI REALLOC...

Card1 TimeSlot=23 Frame=4 at 00:00:02.012875 OK Len=29 *** Right click to SHOW/HIDE layer de

HDLC Frame Data + FCS

```

===== MTP2 Layer =====
0000 BSN          = .0100010 (34)
0000 BIB          = 1..... (1)
0001 FSN          = .0100110 (38)
0001 FIB          = 1..... (1)
0002 LI           = ..011000 MSU Format
===== MTP3 Layer =====
  
```

Hex Dump of the Frame Data

```

+-----+-----+-----+-----+-----+-----+-----+-----+
A2 A6 18 83 09 88 04 14 06 00 00 04 00 01 0C 00  0|  |  |
0A 53 07 02 00 00 0A 01 10 23 00 A4 86         S  #  |
  
```

Device #	Frame Count(Device #)
1	55
total 1	55
2	48
total 2	AR

Call ID	Call Status	Call Start Date & Time	Call Duration	Call Type	Mob.ID (Calling#)	Mob.ID (Called#)	DevNo	TS	SM Data	SmsDe
0	Completed	2013-10-22 19:10:30.291875	00:00:07.994875	Location Update	x11111001		2	23		
1	Completed	2013-10-22 19:10:41.400750	00:00:10.751250	Mobile Originating ...	9483429034	91999887354230	2	23	Ability.c...	
2	Completed	2013-10-22 19:11:05.595750	00:00:42.025375	Mobile Originating ...	x11111001	9341141851	2	23		
3	Completed	2013-10-22 19:11:53.920875	00:00:25.705875	Mobile Terminated...	8867640421	9341141851	2	23		
4	Completed	2013-10-22 19:15:21.230625	00:00:09.390500	Mobile Terminated...	918756342341	918756342313	2	23	Ability.c...	

C:\Program Files\GL Communications Inc\Usk 103 Frames

Supported Platforms

16-Port T1 E1 Breakout-Box

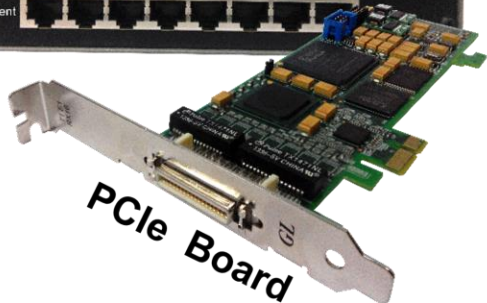

PCIe Board



Quad / Octal T1 E1 PCIe Card



Back Panel

Front Panel

tProbe™ - Portable USB based T1 E1 VF FXO FXS and Serial Datacom Analyzer

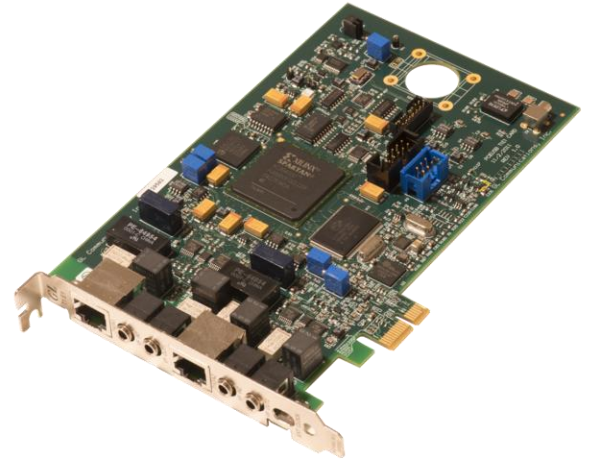

Dual T1 E1 Express (PCIe) Board

Key Features

- Monitor GSM network real-time, offline, as well as remote
- Multiple streams of GSM traffic on various T1 E1 channels can be simultaneously decoded with different GUI instances
 - Displays Summary, Detail, Hex-Dump, Statistics, and Call Detail View
- Any protocol field can be added to the summary view, filtering, and search features providing users more flexibility to monitor required protocol fields
- Option to create multiple aggregate column groups and prioritize the groups as per the requirement to display the summary results efficiently
- Allows the user to create search/filter criteria automatically from the current screen selection
- Captured frames can later be used for traffic simulation
- Remote monitoring capability using GL's Network Surveillance System

Protocol Standards

- A Interface - MTP2, MTP3, SCCP, BSSMAP, SMS, MM, & CC
- Abis Interface – LAPD, BTSM, RR, SMS, MM & CC
- Gs Interface – MTP2, MTP3, BSSAP+
- Lb, Ls, Lp Interface – RRLP, BSSLAP, SMLCPP, LLP, BSSAP-LE, SCCP, MTP3, & MTP2
- UP Interface - UMA Protocols , TCP, UDP, IP, &MAC
- Motorola Proprietary Mobis Interface

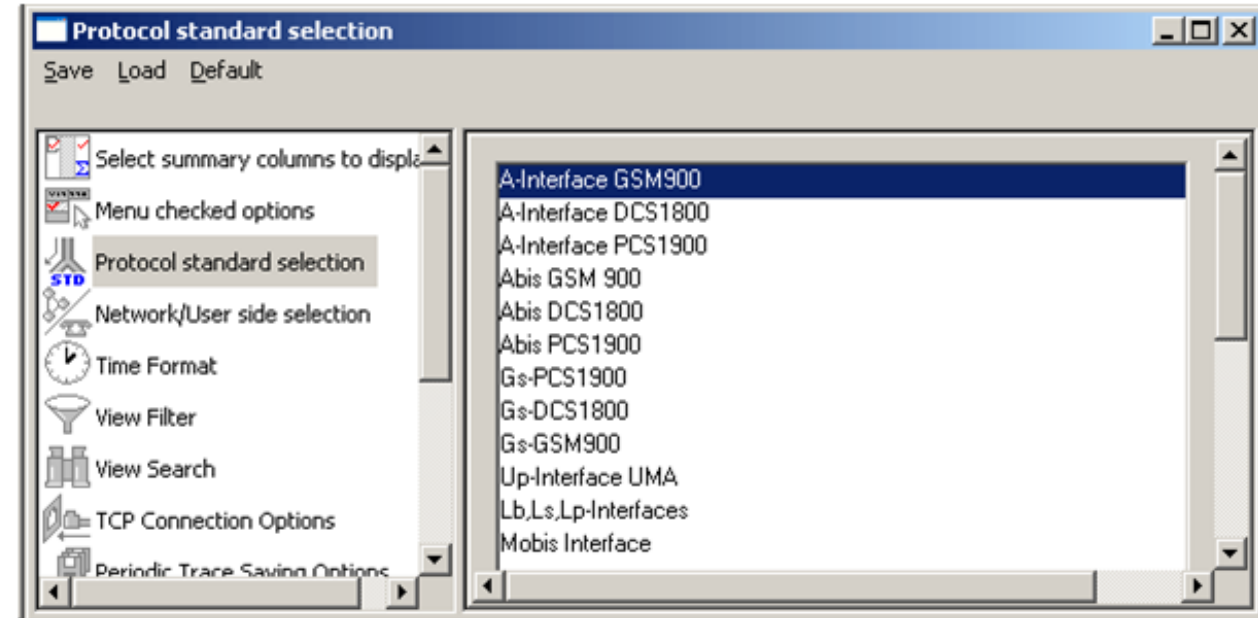

Real-time Capture

The screenshot shows the 'Protocol Capture Configuration' window. On the left, a sidebar contains icons for 'File', 'View', and 'Capture'. The 'Capture' icon is highlighted with a red box. Below the sidebar are menu items: 'Capture File Options', 'Card & Stream Selection', 'Capture Filter', and 'Gui & Protocol Options'. The main window features a table for port configuration and several control panels.

PORT ACTIONS	Port	TS	00	01	02	03	04	05	06	07	08	09	10	11	12	13	14	15	16	17	18	19	20	21	22	23
<input checked="" type="checkbox"/> <input checked="" type="checkbox"/> <input checked="" type="checkbox"/> <input checked="" type="checkbox"/>	1		0	1	2	3																				
<input checked="" type="checkbox"/> <input checked="" type="checkbox"/> <input checked="" type="checkbox"/> <input checked="" type="checkbox"/>	2		0	1	2	3																				

Data Transmission Rate

- Single Channel
 - 64 kbps
 - 56 kbps
- Hyper-Channel
 - Nx64 kbps
 - Nx56 Kbps (bits 1-7)
 - Nx56 Kbps (Bits 2-8)
- Multiple Hyper-Channels
 - 128, 192, ... kbps

Subchannels 8-56 kbps

D50 bits

- 8
- 16
- 24
- 32
- 40
- 48
- 56

All
None

All Port Settings

- HDLC FCS
 - 16 bits
 - 32 bits
 - None
- Interface
 - User
 - Network
- Bit Inversion 1<->0
- Octet Bit Reversion (MSB <-> LSB)

Row (Port) Select, Clear, Paste Operations

Paste operations apply to the clipboard contents created by clicking on a row "C" (copy) button for the port which timeslot selection is served as the source for paste.

Select All
Clear All
Paste All

Paste Clipboard to Port List
Paste List

Filtering Criteria

- Search and Filter features provide very fast search/filter for finding the required frames

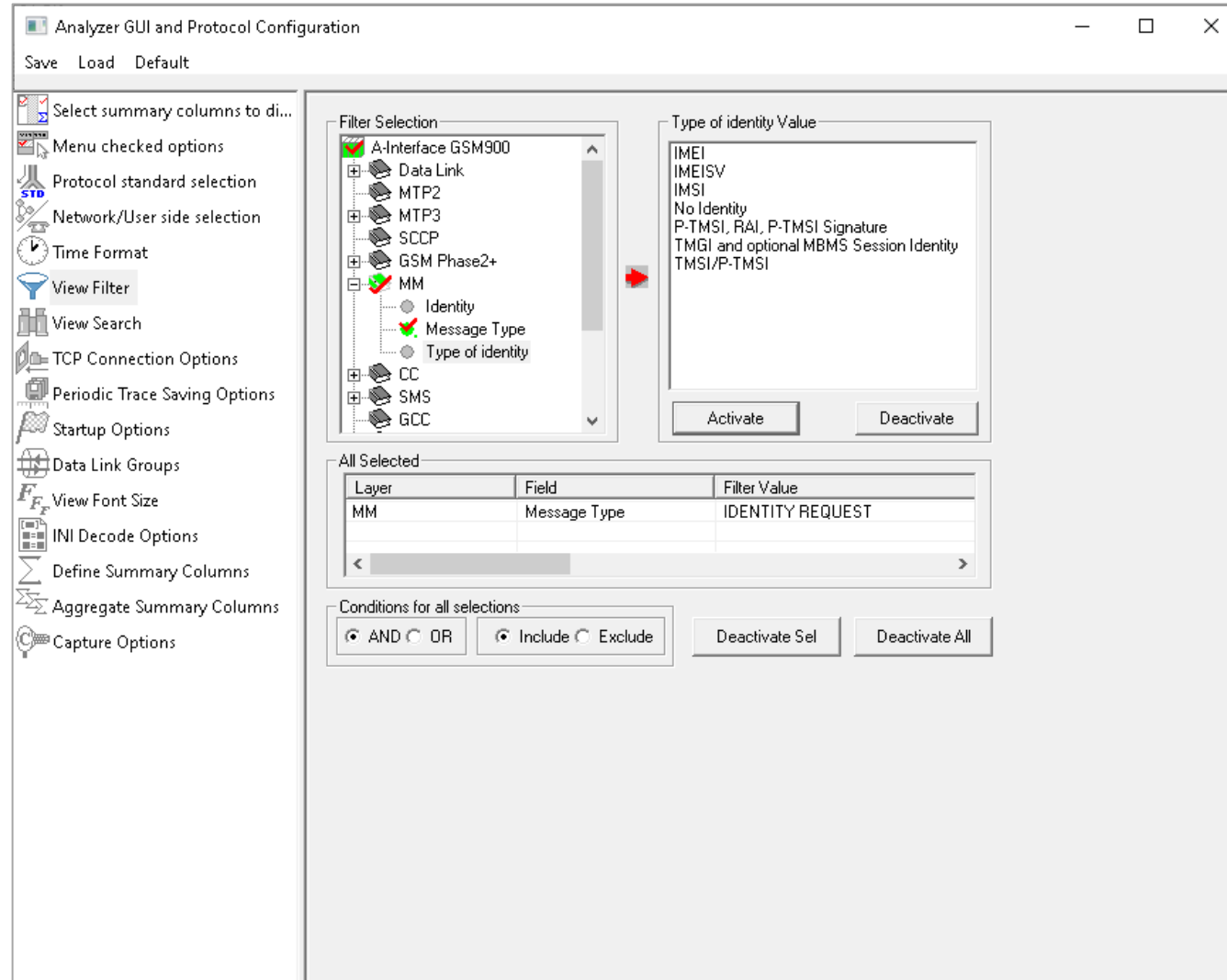

Filtering Criteria From Screen Selection

- Allows the user to create filter criteria automatically from the current screen selection

The screenshot shows the 'GSM Protocol Analysis A-Interface GSM900 64-bit' window. The table below displays the captured data:

Dev	TSlot	SubCh	Frame#	IME (Relative)	Len	Error	OPC MTP3	DPC MTP3	Message Type GSM Phase2+	Message Type RR	Message Type MM	Type of identity MM	Identity MM	Digits<> Calling Ir Dig CC
✓ 1	23		21	00:00:14...	23		2.2.2	1.1.1			IDENTITY REQUEST			
✓ 2	23		22	00:00:15...	31		1.1.1	2.2.2			IDENTITY RESPONSE	Search Selected Value		
✓ 1	23		23	00:00:15...	33		2.2.2	1.1.1			TMSI REALLOCATION	Set Search Criteria as Sel Values		
✓ 2	23		24	00:00:16...	22		1.1.1	2.2.2			TMSI REALLOCATION	Set Filter Criteria as Sel Values		

A dialog box titled 'Use Ctrl, Shift for Extended Selection' is open, showing a list of selected criteria:

- MTP3::DPC
- MTP3::OPC
- MM::Identity
- MM::Message Type
- MM::Type of identity

The 'Set Filter Criteria as Sel Values' option from the table is being used to populate this dialog. The dialog has 'OK', 'Select All', and 'Cancel' buttons.

The 'Analyzer GUI and Protocol Configuration' window is also shown, with the 'Filter Selection' pane. The 'A-Interface GSM900' tree is expanded to 'MTP3'. The 'Value Selection' pane is empty. Below the panes is a table for 'All Selected' filter criteria:

Layer	Field	Filter Value
MTP3	DPC	2.2.2
MTP3	OPC	1.1.1

The 'All Selected' table is highlighted with a red box. Below it are 'Conditions for all selections' (AND/OR) and 'Include/Exclude' radio buttons, along with 'Deactivate Sel' and 'Deactivate All' buttons.

Search Criteria From Screen Selection

- Allows the user to create search criteria automatically from the current screen selection

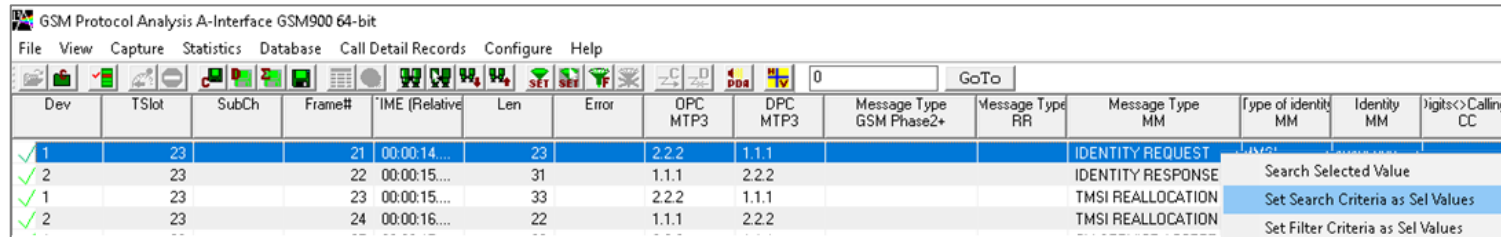

Dev	TSlot	SubCh	Frame#	IME (Relative)	Len	Error	OPC MTP3	DPC MTP3	Message Type GSM Phase2+	Message Type RR	Message Type MM	Type of identity MM	Identity MM	Digits<> Calling CC
✓ 1	23		21	00:00:14...	23		2.2.2	1.1.1			IDENTITY REQUEST			
✓ 2	23		22	00:00:15...	31		1.1.1	2.2.2			IDENTITY RESPONSE			
✓ 1	23		23	00:00:15...	33		2.2.2	1.1.1			TMSI REALLOCATION			
✓ 2	23		24	00:00:16...	22		1.1.1	2.2.2			TMSI REALLOCATION			

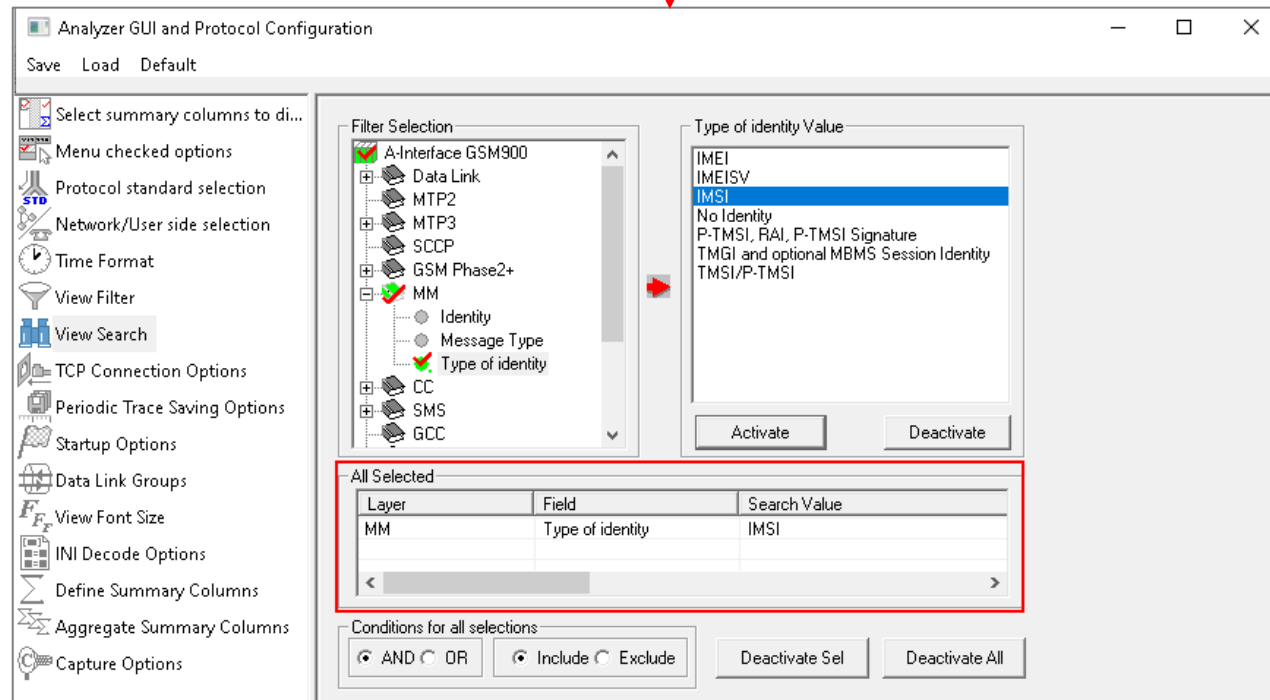
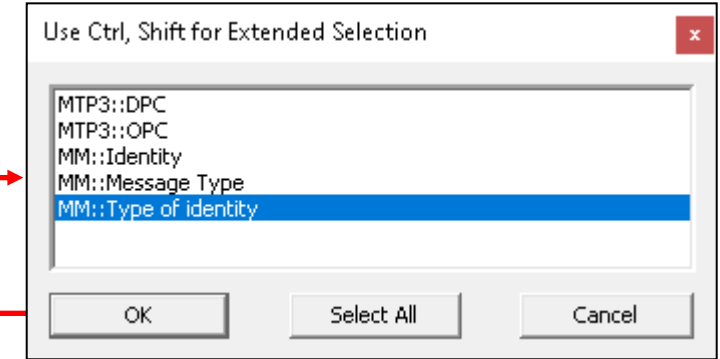

Define Summary Columns

- Required protocol fields can be added through Define summary column option
- User can remove the protocol field which is not required

The image shows a software interface for defining summary columns. On the left is a dialog box titled "Select summary columns to display" with a "Define Summary Columns" option selected in the left-hand menu. The dialog has two main panes: "DISPLAYED summary columns" and "HIDDEN summary columns". The "DISPLAYED" pane contains a list of protocol fields such as Dev, TSlot, SubCh, Frame#, Time, Len, Error, OPC_MTP3, DPC_MTP3, Message Type_GSM Phase2+, Message Type_RR, Message Type_MM, Type of identity_MM, Identity_MM, Number Digits->CallingPartyBCD_CC, Number Digits->CalledParty_CC, Number Digits->RP_Origin_SMS, Address-Value_SMS, and SM_data_SMS. The "HIDDEN" pane is currently empty. Below the panes are buttons for "Sel Only", "All Columns", "Undo Delete", and "Restore".

Overlaid on the bottom right is the main software window, "GSM Protocol Analysis A-Interface GSM900 64-bit". It features a table of captured frames and a detailed view of the selected frame (Frame 70).

Dev	TSlot	SubCh	Frame#	IME (Relative)	Len	Error	Called Number	OPC MTP3	DPC MTP3	Message Type GSM Phase2+	Message Type RR	Message M
✓ 1	23		70	00:01:29...	42		9341141851 --->8867640421	2.2.2	1.1.1			
✓ 2	23		71	00:01:30...	23			1.1.1	2.2.2			
✓ 1	23		72	00:01:31...	40			2.2.2	1.1.1	ASSIGNMENT REQ...		

The detailed view of Frame 70 shows the following structure:

```
Card1 TimeSlot=23 Frame=70 at 00:01:29.676375 OK Len=42 *** Right click to SHOW/HIDE layers
HDLC Frame Data + FCS
===== MTP2 Layer =====
0000 BSN = .1000000 (64)
0000 BIB = 1..... (1)
0001 FSN = .1001010 (74)
0001 FIB = 1..... (1)
0002 LI = ..100101 NSU Format
===== MTP3 Layer =====
0003 Service Indicator = ....0011 SCCP
0003 Priority Code = ..00.... Priority Code 0
0003 Sub-service field = 10..... National Network
0004 DPC = 1.1.1(00001001 ..001000)
0005 OPC = 2.2.2(10..... 00000100 ....0100)
0007 Signalling Link Code = 0001.... (1)
===== SCCP Layer =====
0008 Message Type = 00000110 DT1 data form 1
Mandatory Fixed Parameters =
Destination Local Reference Parameter =
0009 Destination Local Reference = 458752 [hex 070000]
Segmenting Reassembling Parameter =
```

Aggregate Group Column

- The user can create multiple aggregate column groups and prioritize the groups as per the requirement to display the summary results efficiently

The 'Aggregate Summary Columns' dialog box is shown with the following configuration:

Name	Display Format	Summary Columns	Separator
Group~0	Concat	Number Digits<>CallingPartyBCD_CC Number Digits<>CalledParty_CC	--->
Group~1	Col_Alias Value	Type of identity_MM	
Group~2	Concat	DPC_MTP3 OPC_MTP3 Message Type_GSM Phase2+	

The main window displays a table of network data. A red box highlights the 'Group~0' column, which contains concatenated values for 'Number Digits' and 'CalledParty_CC'.

Dev	TSlot	SubCh	Frame#	IME (Relative)	Len	Error	Group~0	OPC MTP3	DPC MTP3	Message Type GSM Phase2+
✓ 1	23		70	00:01:29...	42		9867640421 --->9341141851	2.2.2	1.1.1	
✓ 2	23		71	00:01:30...	23		2.2.2&1.1.1	1.1.1	2.2.2	
✓ 1	23		72	00:01:31...	40		1.1.1 & 2.2.2 & ASSIGNMENT REQUEST	2.2.2	1.1.1	ASSIGNMENT REQ...
✓ 2	23		73	00:01:31...	36		2.2.2&1.1.1 & ASSIGNMENT COMPLETE	1.1.1	2.2.2	ASSIGNMENT CO...
✓ 2	23		74	00:01:31...	22		2.2.2&1.1.1	1.1.1	2.2.2	
✓ 2	23		75	00:01:41...	22		2.2.2&1.1.1	1.1.1	2.2.2	
✓ 1	23		76	00:01:42...	22		1.1.1 & 2.2.2	2.2.2	1.1.1	
✓ 1	23		77	00:01:45...	29		1.1.1 & 2.2.2	2.2.2	1.1.1	
✓ 2	23		78	00:01:46...	38		2.2.2&1.1.1	1.1.1	2.2.2	

The main window also displays the HDLC Frame Data + FCS for the selected frame (Frame 70):

```

Card1 TimeSlot=23 Frame=70 at 00:01:29.676375 OK Len=42
HDLC Frame Data + FCS
----- MTP2 Layer -----
0000 BSN = .1000000 (64)
0000 BIB = 1..... (1)
0001 FSN = .1001010 (74)
0001 FIB = 1..... (1)
0002 LI = .100101 MSU Format
----- MTP3 Layer -----
0003 Service Indicator = ....0011 SCCP
0003 Priority Code = .00.... Priority Code 0
0003 Sub-service field = 10..... National Network
0004 DPC = 1.1.1(00001001 ..001000)
0005 OPC = 2.2.2(10..... 00000100 ....0100)
0007 Signalling Link Code = 0001.... (1)
----- SCCP Layer -----
0008 Message Type = 00000110 DT1 data form 1
Mandatory Fixed Parameters =
Destination Local Reference Parameter =
0009 Destination Local Reference = 458752 [hex 070000]
Segmenting Reassembling Parameter =
  
```

Call Detail Records

- Call trace defining important call specific parameters such as call ID, status (active or completed), duration, CRV, release complete cause etc. are displayed

GSM Protocol Analysis Abis GSM 900

File View Capture Statistics Database Call Detail Records Configure Help

0 GoTo

Dev	TSlot	Frame#	SubCh	Len	TIME (Relative)	Error	MM-Message	TMSI	CC-Message	Called Party/Called Subaddress
✓ 2	23	0	6-7	47	00:00:00.000000					
✓ 2	23	1	6-7	47	00:00:00.480000					
✓ 2	23	2	6-7	47	00:00:00.960000					
✓ 2	23	3	6-7	46	00:00:01.357000					
✓ 1	23	4	6-7	6	00:00:01.386000					

Call ID	Call Status	Call Start Date & Time	Call Duration	DevNo	TS	OPC	DPC	Call Type	Mob.ID1(Calling#)	Mob.ID2(Call...)	Release
0	completed	2002-10-02 17:21:20.986500	00:00:01.905000	1	0			Speech Call	14253784000		
1	completed	2002-10-02 17:21:22.878000	00:00:02.383500	1	1			Speech Call	14254451412		
2	completed	2002-10-02 17:21:30.877000	00:00:02.186500	1	0			Speech Call	x52B73DA2-TMSI	4252683426	
3	completed	2002-10-02 17:21:44.742000	00:00:02.182500	1	1			Speech Call	14253784000		

C:\Program Files\GL Communicator 926 Frames

Applications

- Used as independent standalone units as "probes" integrated in a network surveillance systems
- Triggering, collecting, and filtering for unique subscriber information and relaying such information to a back end processor
- Collecting Call Detail Records (CDR) information for billing

MAPS™ GSM A Emulator (Testing over T1 E1)

MAPS™ - GSM A Emulator (XX692)

- Scripted GSM A Interface simulation over TDM (T1 E1) using GL's MAPS™
- Simulates BSC and MSC entities

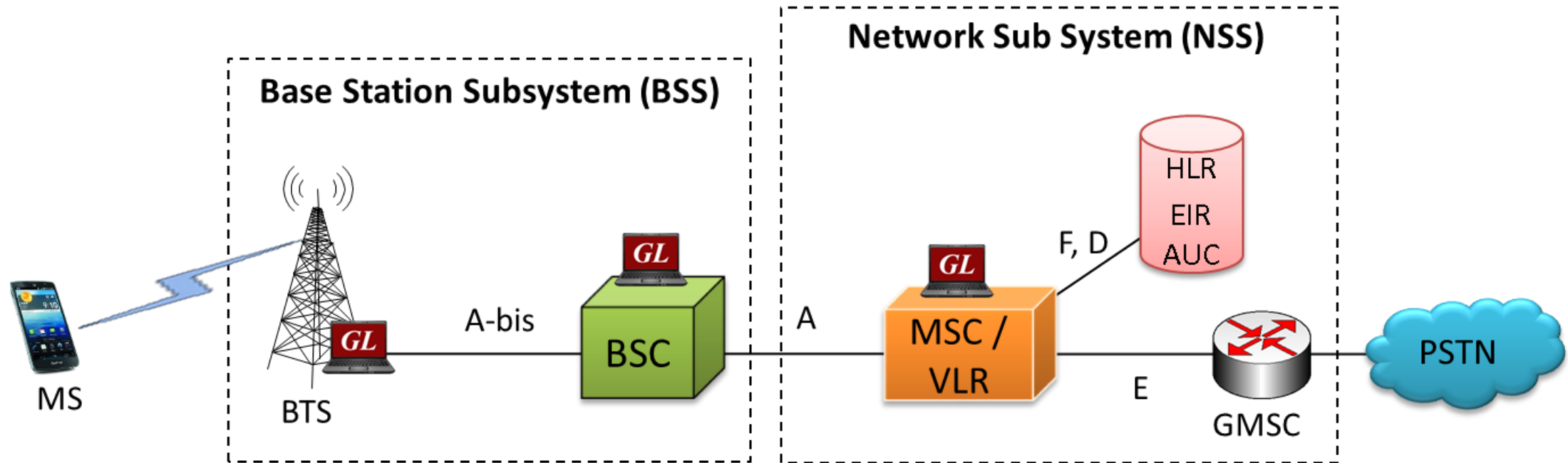

 MAPS™ in GSM Network

Supported Protocol Standards

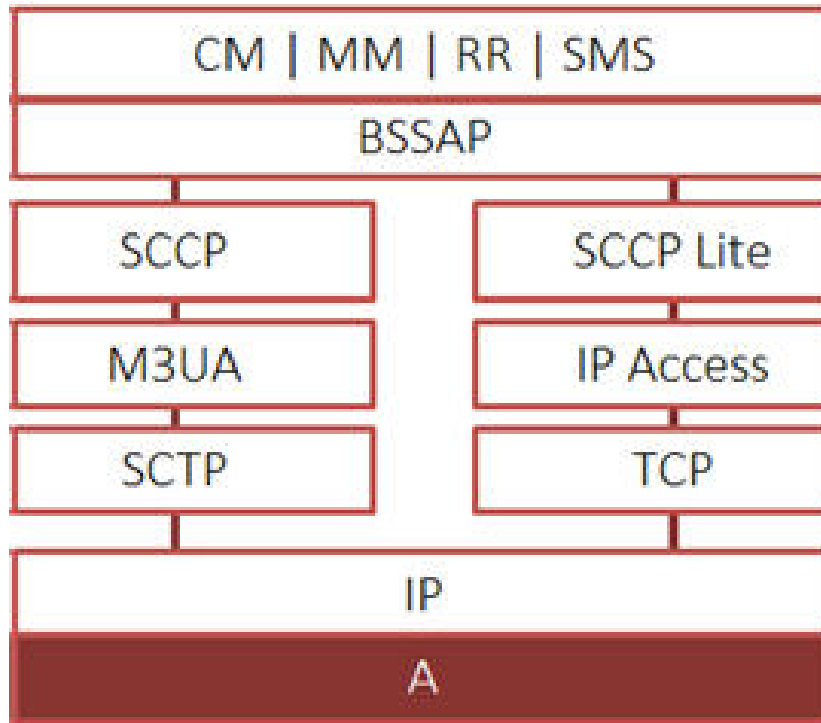

Supported Protocols	Standard / Specification Used
SCCP	Q.713, CCITT (ITU-T) Blue Book
SCTP	RFC 4960
TCP	RFC 793
M3UA	RFC 3332
BSSMAP / DTAP	3GPP TS 08.08 V8.9.0, 3GPP TS 48.008 V10.0.0 (2011-01)
MM/CC	3GPP TS 04.08 V7.17.0
RR	3GPP TS 04.18 V8.13.0
SMS	3GPP TS 03.40 V7.5.0 & 3GPP TS 04.11 V7.1.0 GSM 03.38 version 7.2.0 Release 1998

GSM A Mobile Originating Call Flow

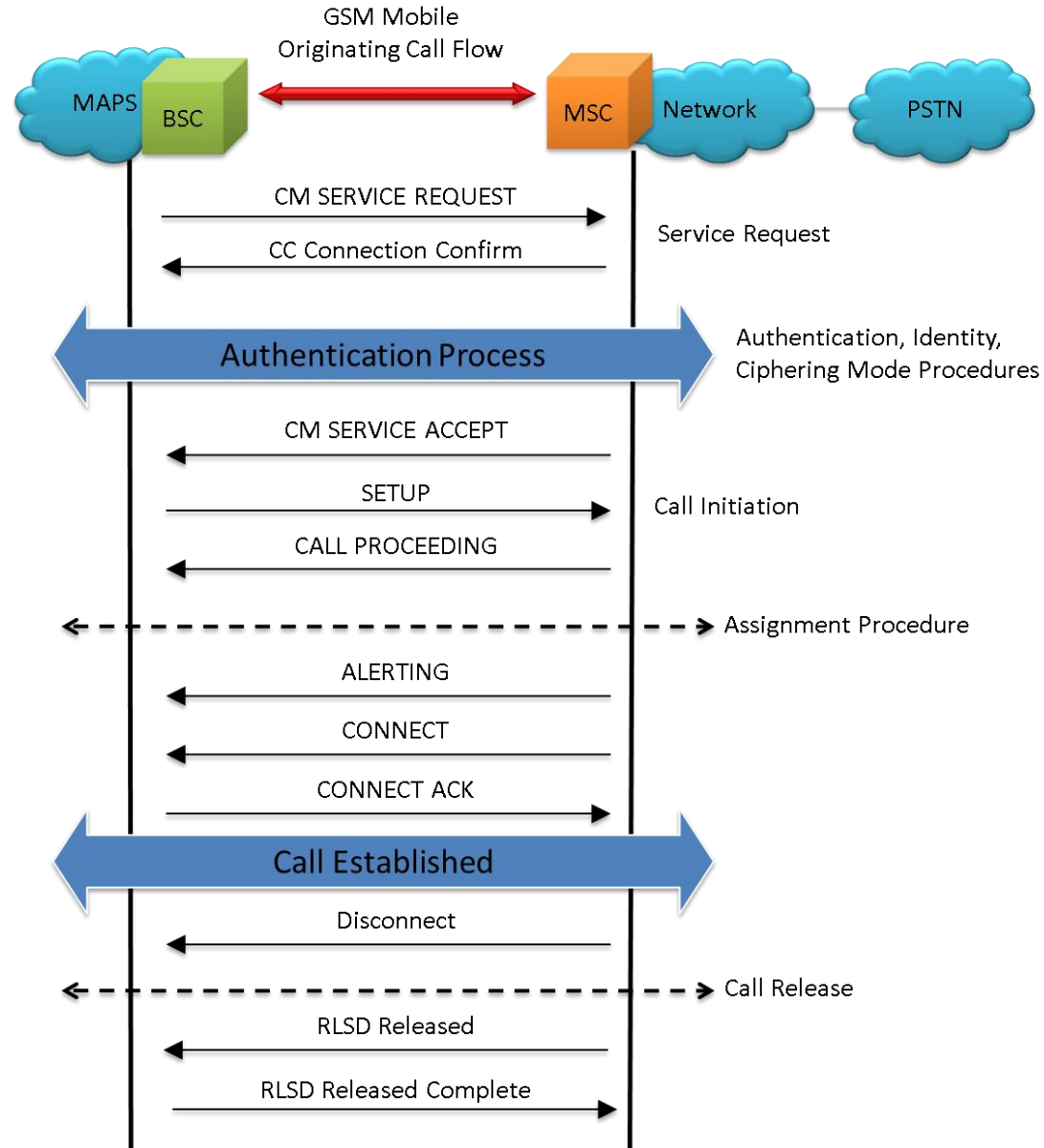

GSM A Mobile Terminating Call Flow

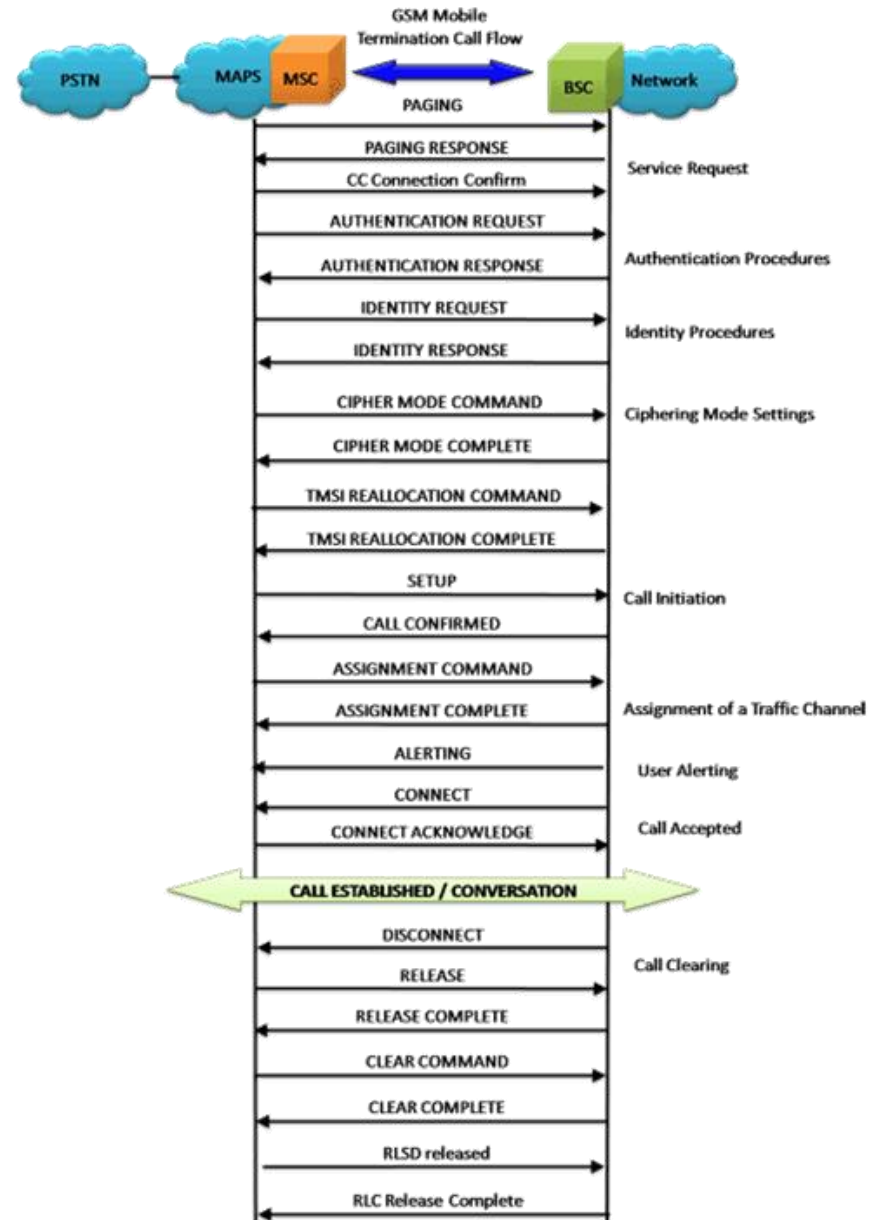

Location Updating Call Flow

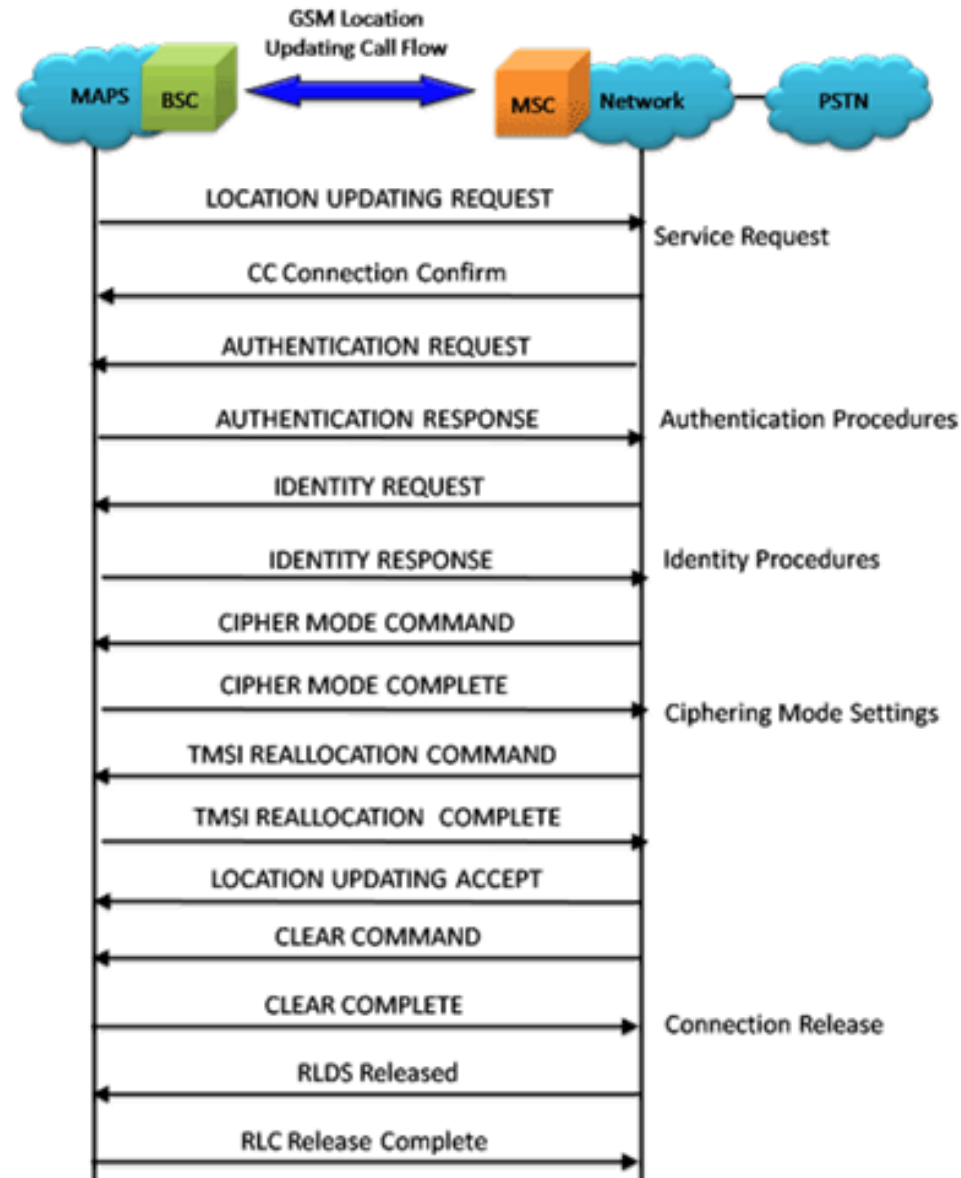

GSM A Call Generation

GL MAPS (Message Automation Protocol Simulation) BSC (GsmA GSM900) - [Call Generation - CallGenDefault]

Configurations Emulator Reports Editor Debug Tools Windows Help

Sr...	Script Name	Profile	Call Info	Script Execution	Status	Events	Eve...	Result	Total Iterat...	Cc ^
1	GSMA_Call.gls	MSPProfile0001	IMSI_90170000000063...	Start	SCCP Connection Released	None		Pass	1	
2	GSMA_Call.gls	MSPProfile0002	IMSI_90170000000063...	Start	SCCP Connection Released	None		Pass	1	
3	GSMA_Call.gls	MSPProfile0003	IMSI_90170000000064...	Start	SCCP Connection Released	None		Pass	1	
4	GSMA_Call.gls	MSPProfile0004	IMSI_90170000000064...	Start	SCCP Connection Released	None		Pass	1	
5	GSMA_Call.gls	MSPProfile0005	IMSI_90170000000064...	Start	SCCP Connection Released	None		Pass	1	
6	GSMA_Call.gls	MSPProfile0006	IMSI_90170000000064...	Start	SCCP Connection Released	None		Pass	1	
7	GSMA_Call.gls	MSPProfile0007	IMSI_90170000000064...	Start	SCCP Connection Released	None		Pass	1	
8	GSMA_Call.gls	MSPProfile0008	IMSI_90170000000064...	Start	SCCP Connection Released	None		Pass	1	
9	GSMA_Call.gls	MSPProfile0009	IMSI_90170000000064...	Start	SCCP Connection Released	None		Pass	1	
10	GSMA_Call.gls	MSPProfile0010	IMSI_90170000000064...	Start	SCCP Connection Released	None		Pass	1	

Add Delete Insert Refresh Start Start All Stop Stop All Abort Abort All

Save Column Width Show Latest

BSC MSC

LOCATION UPDATING REQUEST → 18:07:44.018000

← CC connection confirm 18:07:44.614000

← AUTHENTICATION REQUEST 18:07:44.624000

→ AUTHENTICATION RESPONSE 18:07:44.625000

← CIPHER MODE COMMAND 18:07:45.205000

→ CIPHER MODE COMPLETE 18:07:45.205000

← LOCATION UPDATING ACCEPT 18:07:45.785000

Find

```

===== MTP3 Layer =====
0000 Service Indicator = ...0011 SCCP
0000 Priority Code = ..00.... Prio:
0000 Sub-service field = 10..... Natic
0001 DPC = 2.2.2(0001001)
0002 OPC = 1.1.1(01.....
0004 Signalling Link Code = 0001.... (1)
Higher Layer Data = x010000050202(
===== SCCP Layer =====
0005 Message Type = 00000001 CR cc
Mandatory Fixed Parameters =
Source Local Reference Parameter =
0006 Source Local Reference = 5 (x000005)
Protocol Class Parameter =
0009 Class = ...0010 Class
0009 Message Handling (Class 0 and 1 only) = 0000.... No S
    
```

Scripts Message Sequence Event Config Script Flow Capture Events

Initialisation Errors Error Events Captured Errors Link Status U

GSM A Call Reception

MAPS (Message Automation Protocol Simulation) MSC (GsmA GSM900) - [Call Reception]

Configurations Emulator Reports Editor Windows Help

Sr No	Script Name	Call Info	Script Execution	Status	Events	Events...	Results
1	SLTM.gls	2,2,2,1,1,1,1	Abort	MTP3 Active	Initiate SLTM		Pass
2	SCMS.gls	1	Abort	Subsystem Allowed	Initiate SST		Pass
3	MO.gls	IMSI_901700000000601...	Abort	File Sent	Terminate		Pass
4	MO.gls	IMSI_901700000000602...	Abort	File Sent	Terminate		Pass
5	MO.gls	IMSI_901700000000603...	Abort	File Sent	Terminate		Pass
6	MO.gls	IMSI_901700000000604...	Abort	File Sent	Terminate		Pass
7	MO.gls	IMSI_901700000000605...	Abort	File Sent	Terminate		Pass
8	MO.gls	IMSI_901700000000606...	Abort	File Sent	Terminate		Pass
9	MO.gls	IMSI_901700000000607...	Abort	File Sent	Terminate		Pass

Abort Abort All Show Records Auto Trash Trash

Save Column Width

DUT MAPS

```

CM SERVICE REQUEST → 17:57:30.184000
← CC connection confirm 17:57:30.187000
← AUTHENTICATION REQUEST 17:57:30.188000
→ AUTHENTICATION RESPONSE 17:57:30.764000
← CIPHER MODE COMMAND 17:57:30.765000
→ CIPHER MODE COMPLETE 17:57:31.348000
← TMSI REALLOCATION COMMAND 17:57:31.349000
→ TMSI REALLOCATION COMPLETE 17:57:31.943000
← CM SERVICE ACCEPT 17:57:31.944000
        
```

```

***** MTP3 Layer *****
0000 Service Indicator = ....0011 SCCP
0000 Priority Code = ..00.... Priority Code 0
0000 Sub-service field = 10..... National Network
0001 DPC = 2,2,2(00010010 ..010000)
0002 OPC = 1,1,1(01..... 00000010 ....0010)
0004 Signalling Link Code = 0001.... (1)
Higher Layer Data = x0500001702020604C91210FE0404C30908FE
***** SCCP Layer *****
0005 Message Type = 00000001 CR connection request
Mandatory Fixed Parameters =
Source Local Reference Parameter =
0006 Source Local Reference = 23 (x000017)
Protocol Class Parameter =
0009 Class = ....0010 Class 2
0009 Message Handling (Class 0 and 1 only) = 0000.... No Special Options
000A Pointer to Mandatory Parameter = Param0 offset x02 (2)
000B Pointer to optional parameters = x06 (6)
Mandatory Variable Length Parameters =
Called Party Address = mandatory parameter
000C Parameter length = 4
Address Indicators =
000D Refer Code To Destination = 1 Address indicator signalling
        
```

Scripts Message Sequence Event Config Script Flow

Error Events Captured Errors Link Status Up=1 Down=0

MAPS™ GSMA Command Line Interface (CLI)

MAPS GSMA CLI Server

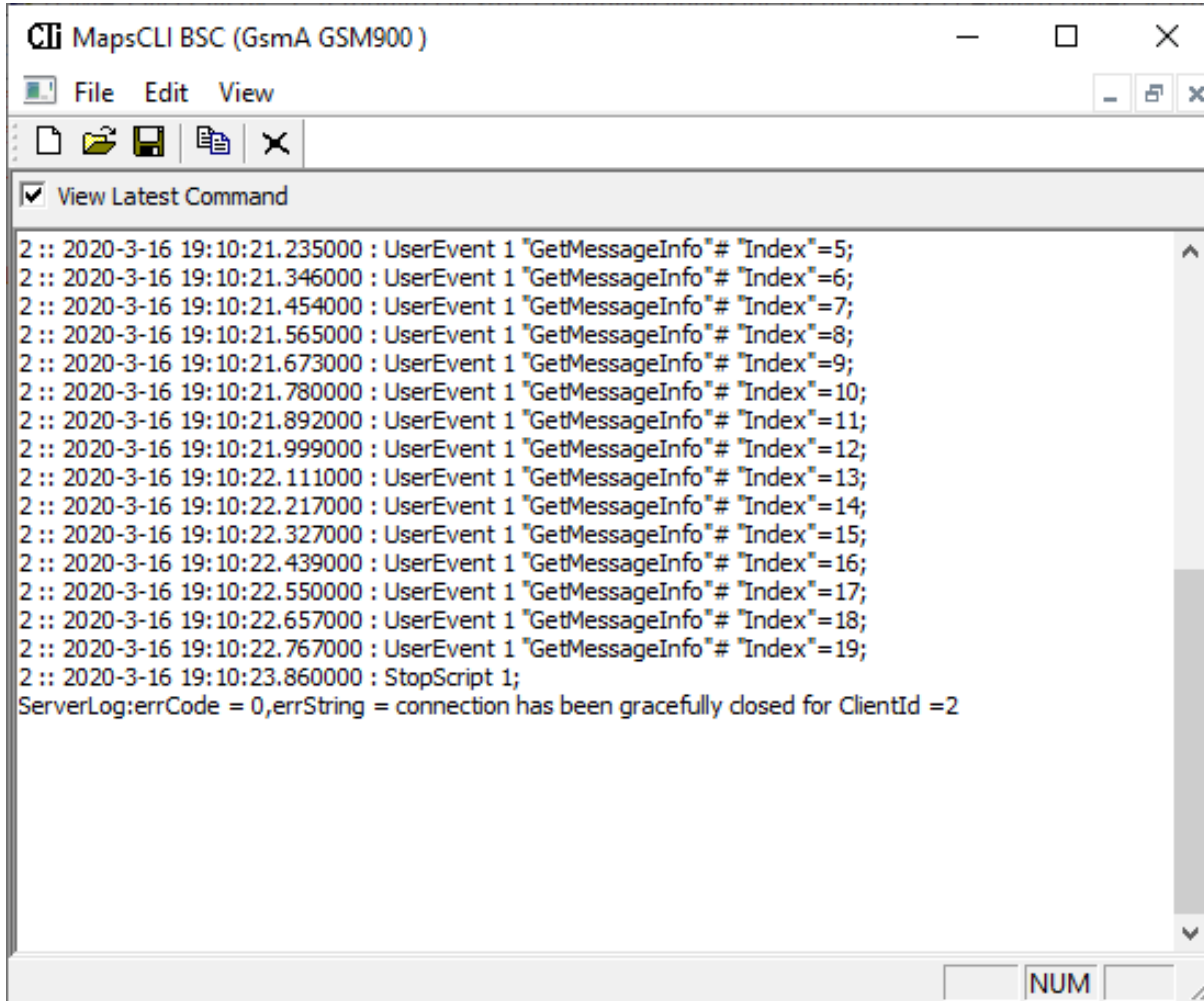

```
CLI MapsCLI BSC (GsmA GSM900)
File Edit View
View Latest Command
2 :: 2020-3-16 19:10:21.235000 : UserEvent 1 "GetMessageInfo"# "Index"=5;
2 :: 2020-3-16 19:10:21.346000 : UserEvent 1 "GetMessageInfo"# "Index"=6;
2 :: 2020-3-16 19:10:21.454000 : UserEvent 1 "GetMessageInfo"# "Index"=7;
2 :: 2020-3-16 19:10:21.565000 : UserEvent 1 "GetMessageInfo"# "Index"=8;
2 :: 2020-3-16 19:10:21.673000 : UserEvent 1 "GetMessageInfo"# "Index"=9;
2 :: 2020-3-16 19:10:21.780000 : UserEvent 1 "GetMessageInfo"# "Index"=10;
2 :: 2020-3-16 19:10:21.892000 : UserEvent 1 "GetMessageInfo"# "Index"=11;
2 :: 2020-3-16 19:10:21.999000 : UserEvent 1 "GetMessageInfo"# "Index"=12;
2 :: 2020-3-16 19:10:22.111000 : UserEvent 1 "GetMessageInfo"# "Index"=13;
2 :: 2020-3-16 19:10:22.217000 : UserEvent 1 "GetMessageInfo"# "Index"=14;
2 :: 2020-3-16 19:10:22.327000 : UserEvent 1 "GetMessageInfo"# "Index"=15;
2 :: 2020-3-16 19:10:22.439000 : UserEvent 1 "GetMessageInfo"# "Index"=16;
2 :: 2020-3-16 19:10:22.550000 : UserEvent 1 "GetMessageInfo"# "Index"=17;
2 :: 2020-3-16 19:10:22.657000 : UserEvent 1 "GetMessageInfo"# "Index"=18;
2 :: 2020-3-16 19:10:22.767000 : UserEvent 1 "GetMessageInfo"# "Index"=19;
2 :: 2020-3-16 19:10:23.860000 : StopScript 1;
ServerLog:errCode = 0,errString = connection has been gracefully closed for ClientId =2
NUM
```

Sample Python Client Script

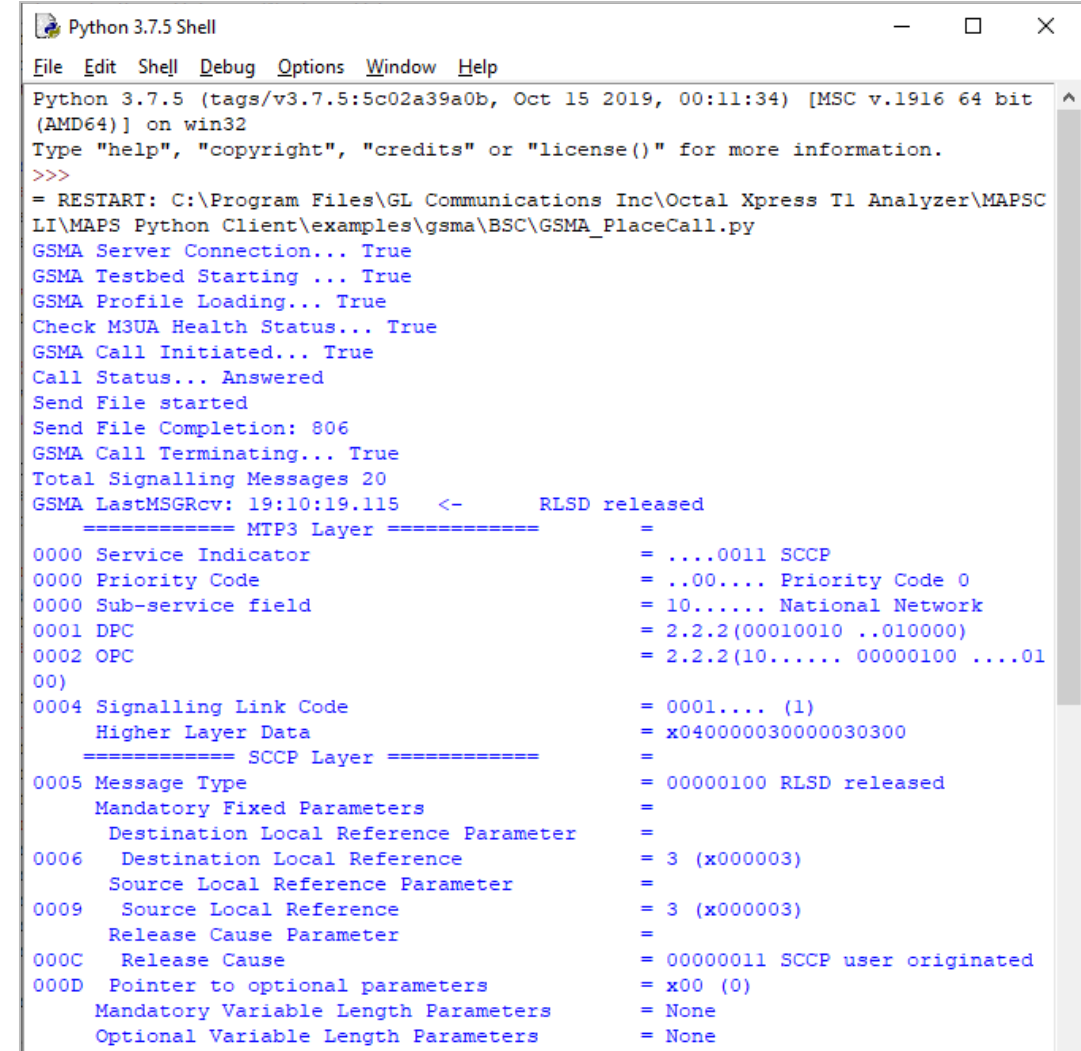



```
Python 3.7.5 Shell
File Edit Shell Debug Options Window Help
Python 3.7.5 (tags/v3.7.5:5c02a39a0b, Oct 15 2019, 00:11:34) [MSC v.1916 64 bit
(AMD64)] on win32
Type "help", "copyright", "credits" or "license()" for more information.
>>>
= RESTART: C:\Program Files\GL Communications Inc\Octal Xpress T1 Analyzer\MAPSC
LI\MAPS Python Client\examples\gsma\BSC\GSMA_PlaceCall.py
GSMA Server Connection... True
GSMA Testbed Starting ... True
GSMA Profile Loading... True
Check MSUA Health Status... True
GSMA Call Initiated... True
Call Status... Answered
Send File started
Send File Completion: 806
GSMA Call Terminating... True
Total Signalling Messages 20
GSMA LastMSGRcv: 19:10:19.115 <- RLSd released
===== MTP3 Layer =====
0000 Service Indicator = ...0011 SCCP
0000 Priority Code = ..00.... Priority Code 0
0000 Sub-service field = 10..... National Network
0001 DPC = 2.2.2(00010010 ..010000)
0002 OPC = 2.2.2(10..... 00000100 ....01
00)
0004 Signalling Link Code = 0001.... (1)
Higher Layer Data = x0400000300000030300
===== SCCP Layer =====
0005 Message Type = 00000100 RLSd released
Mandatory Fixed Parameters =
Destination Local Reference Parameter =
0006 Destination Local Reference = 3 (x0000003)
Source Local Reference Parameter =
0009 Source Local Reference = 3 (x0000003)
Release Cause Parameter =
000C Release Cause = 00000011 SCCP user originated
000D Pointer to optional parameters = x00 (0)
Mandatory Variable Length Parameters = None
Optional Variable Length Parameters = None
```

MAPS™ GSM Abis Emulator (Testing over T1 E1)

MAPS™ - GSM Abis in the Network

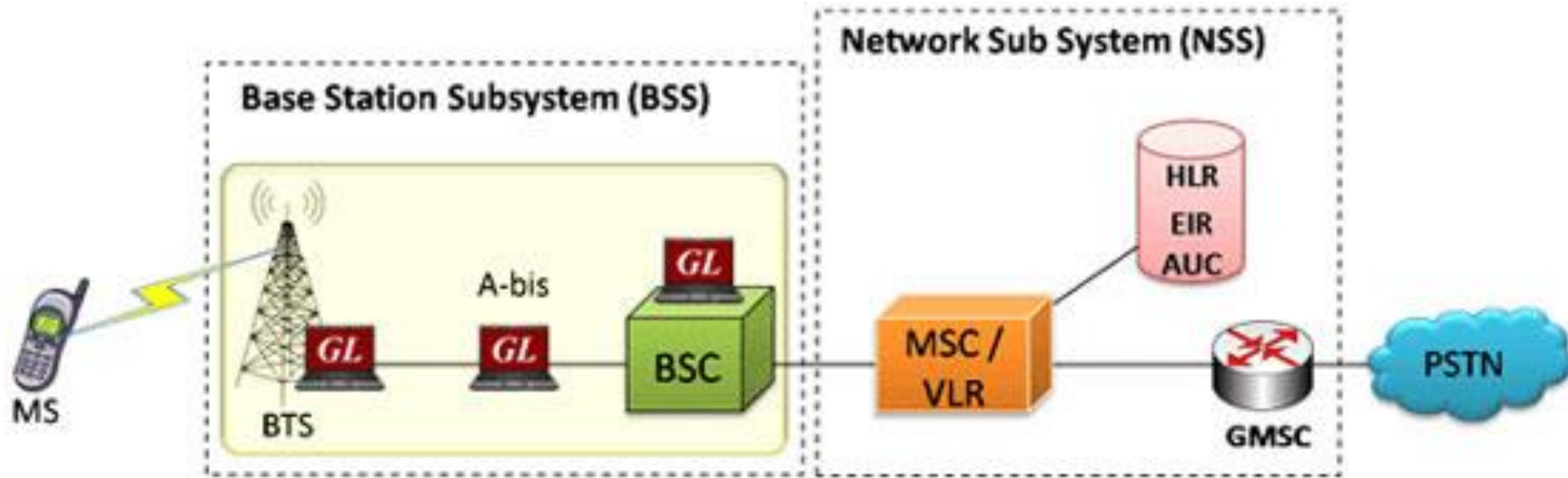
- Scripted GSM Abis Interface simulation over TDM (T1 E1) using MAPS™
- Simulates BSC and BTS entities



 **MAPS™ GSM-Abis Interface**
Simulate elements in GSM network

Supported Protocol Standards

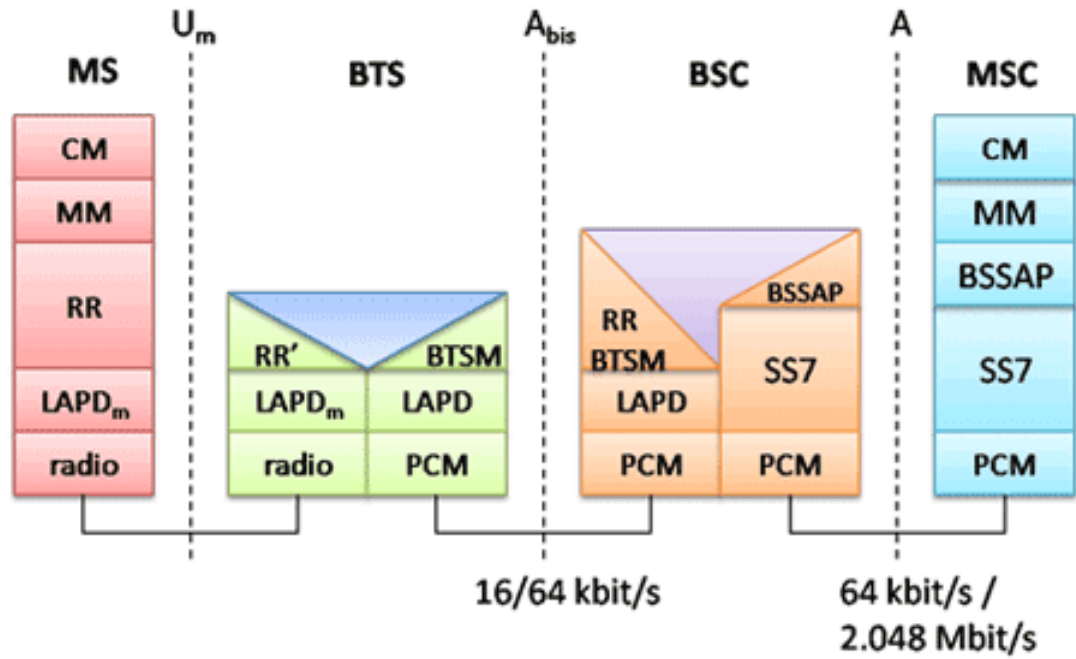

Available Standards	Supported Protocols	Standard / Specification Used
GSM Abis 900	BTSM	3GPP TS 08.58 V8.6.0
	MM	3GPP TS 04.08 V7.17.0
	CC	3GPP TS 04.08 V7.17.0
	RR	3GPP TS 04.18 V8.13.0
	SMS	3GPP TS 03.40 V7.5.0 & 3GPP TS 04.11 V7.1.0 GSM 03.38 version 7.2.0 Release 1998

GSM Abis Mobile Originating Call Flow

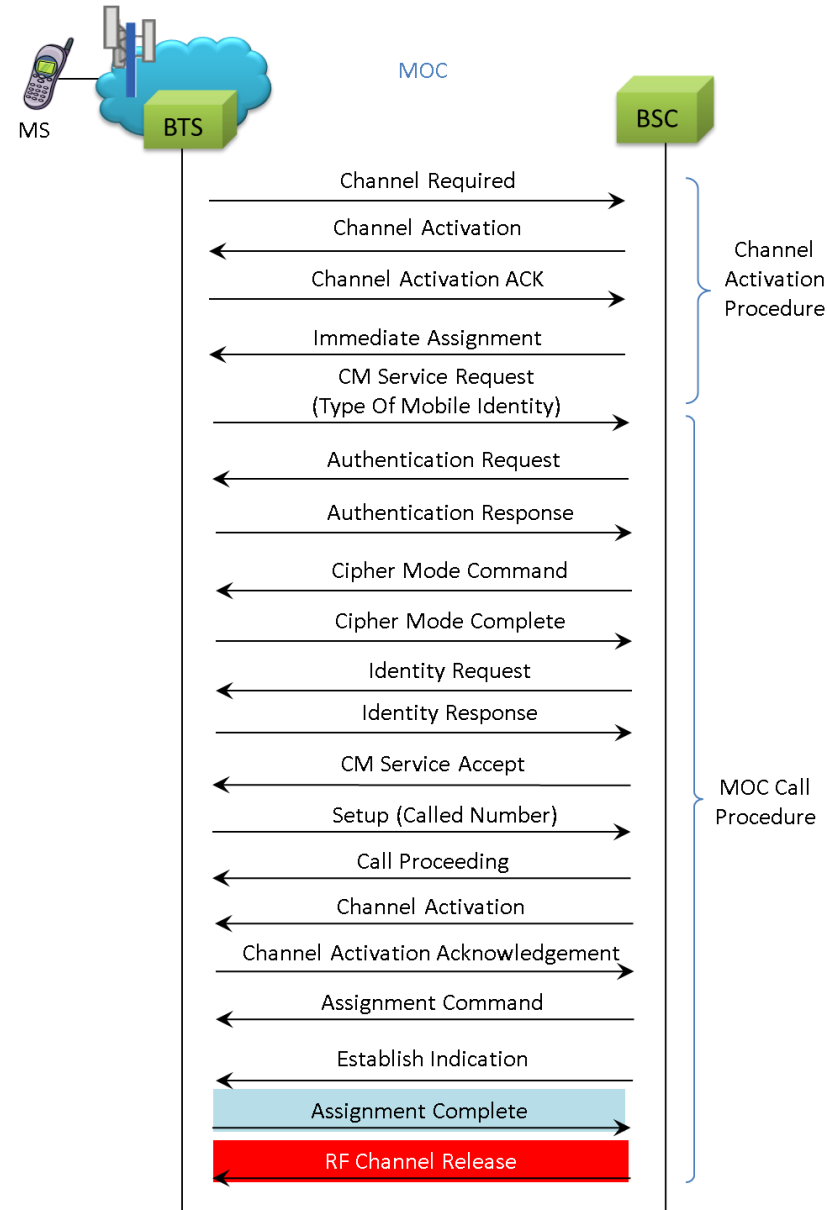

GSM Abis Mobile Terminating Call Flow

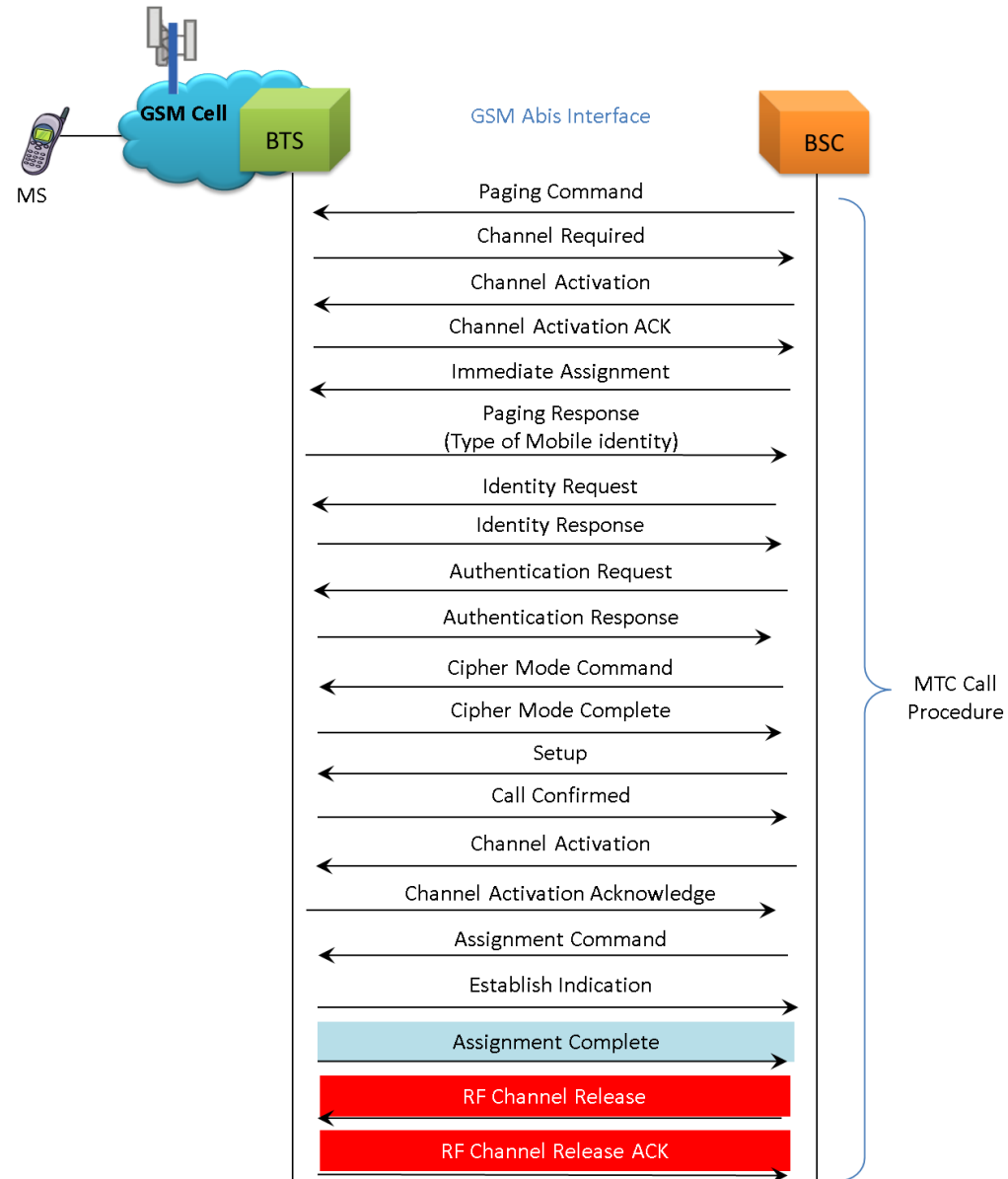

GSM Abis Location Updating Call Flow

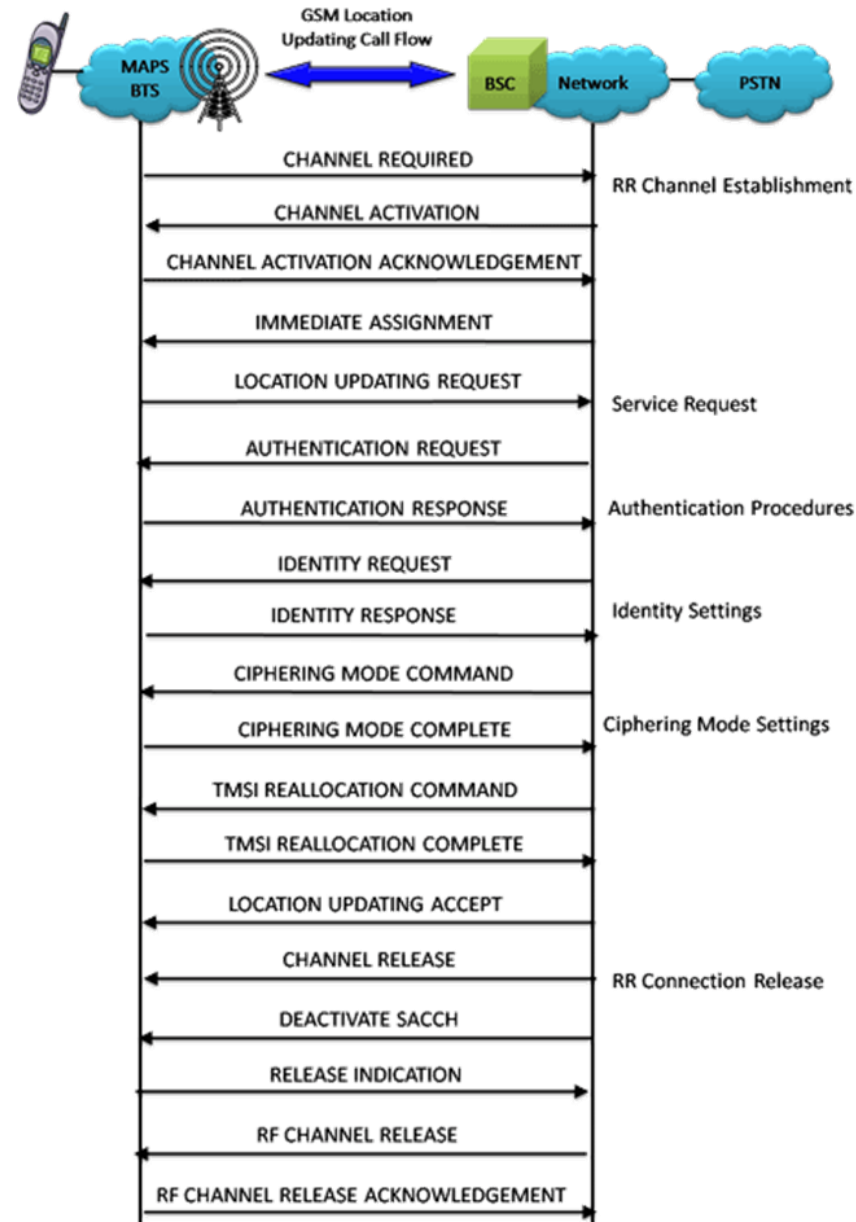

GSM Abis Call Generation

MAPS (Message Automation Protocol Simulation) BTS (GsmAbis GSM900) - [Call Generation - Master Configuration]

Configurations Emulator Reports Editor Debug Tools Windows Help

Sr	Script Name	Profile	Call Info	Script Execution	Status	Events	Event	Result	Total Iteratio	Comp
1	GSMAbis_Call.gls	MSProfile0001	IMSI: 901700000000638, TMSI: 0x...	Start	RF Channel Released	None		Pass	1	
2	GSMAbis_Call.gls	MSProfile0002		Start		None		Unknown	1	

Column Width
 Show Latest

BTS BSC

Channel Required → 11:23:51.975000

← Immediate Assignment 11:23:52.613000

CM SERVICE REQUEST → 11:23:52.630000

CLASSMARK CHANGE → 11:23:52.645000

MEASUREMENT REPORT → 11:23:52.656000

← AUTHENTICATION REQUEST 11:23:52.942000

AUTHENTICATION RESPONSE → 11:23:52.942000

MEASUREMENT REPORT → 11:23:53.116000

← CIPHERING MODE COMMAND 11:23:53.260000

CIPHERING MODE COMPLETE → 11:23:53.261000

SETUP → 11:23:53.283000

Find

```

***** BTSM Layer *****
0000 T-bit = .....1 Trasp
0000 Message Group = 0000001, Radio
0001 Message Type = 00000010 DATA :
Channel number =
0002 IE Identifier(Ch No) = 00000001 Chan
0003 Channel Type = 01001... SDCCM
0003 Sub-Channel #(T bits) = 1 (...001...)
0003 Time Slot # = .....001 (1)
Link Identifier =
0004 IE Identifier(LinkId) = 00000010 Link :
0005 SAPI Value = .....000 SAPI
0005 Priority = ...00... Norma
0005 NA = ..0.... Link :
0005 SAPI Value Channel Type = 00..... Main :
L3 Information =
0006 IE Identifier(L3Info) = 00001011 L3 In:
0007 Length of L3 Information = 6 (x0006)
Layer 3 Information = x05549907E0F3
***** Layer3 Protocol Layer *****
0009 Protocol Discriminator = ...0101 Mobil:
0009 Skip Indicator = 0000.... (0)
***** MM Layer *****
000A Message Type = ..010100 AUTHZ
000A Sequence Number = 01..... (1)
          
```

Initialisation Errors
 Error Events
 Captured Errors
 Link Status Up=1 Down=0

GSM Abis Call Reception

MAPS (Message Automation Protocol Simulation) BSC (GsmAbis GSM900) - [Call Reception]

Configurations Emulator Reports Editor Debug Tools Windows Help

Sr No	Script Name	Profile	Call Info	Script Execution	Status	Events	Event...	Results
1	TRX_Management.gls		1	Stop		Initialize BTS		Pass
2	GSMAbis_Call.gls		IMSI: 901700000000638.TMSI: ...	Completed	RF Channel Released	None		Pass
3	GSMAbis_Call.gls		IMSI: 901700000000638.TMSI: ...	Completed	RF Channel Released	None		Pass

Stop Stop All Abort Abort All Show Records Select Active Call Auto Trash Trash

Save Column Width Show Latest

MEASUREMENT REPORT → 11:05:42.922000

CIPHERING MODE COMPLETE → 11:05:43.142000

LOCATION UPDATING ACCEPT ← 11:05:43.170000

CHANNEL RELEASE ← 11:05:43.185000

DEACTIVATE SACCH ← 11:05:43.194000

MEASUREMENT REPORT → 11:05:43.194000

MEASUREMENT REPORT → 11:05:43.417000

TMSI REALLOCATION COMPLETE → 11:05:43.527000

RELease INDication → 11:05:43.538000

RF CHANnel RELease ← 11:05:43.549000

MEASUREMENT REPORT → 11:05:43.680000

RF CHANnel RELease ACKnowledge → 11:05:43.902000

Find

```

***** BISH Layer *****
0000 T-bit = .....1 Tra
0000 Message Group = 0000001. Bad
0001 Message Type = 00000010 DAT
      Channel number =
0002 IE Identifier(Ch No) = 00000001 Cha
0003 Channel Type = 01000... SDC
0003 Sub-Channel #(T bits) = 0 {...000...}
0003 Time Slot # = .....001 (1)
      Link Identifier =
0004 IE Identifier(LinkId) = 00000010 Lin
0005 SAPI Value = .....000 SAP
0005 Priority = ...00... Nor
0005 NA = ..0..... Lin
0005 SAPI Value Channel Type = 00..... Hai
      L3 Information =
0006 IE Identifier(L3Info) = 00001011 L3
0007 Length of L3 Information = 2 (x0002)
      Layer 3 Information = x0632
***** Layer3 Protocol Layer *****
0009 Protocol Discriminator = ...0110 Bad
0009 Skip Indicator = 0000.... (0)
***** RR Layer *****
000A Message Type = 00110010 CIP
    
```

Scripts Message Sequence Event Config Script Flow

● Initialisation Errors ● Error Events ● Captured Errors ● Link Status Up=1 Down:

MAPS™ - GSMAoIP (GSM A over IP) (PKS137)

MAPS™ - GSMAoIP

- Scripted GSM A simulation over IP using MAPS™
- Simulates BSC or MSC entities
- User-friendly GUI for configuring the SCTP Layer parameters

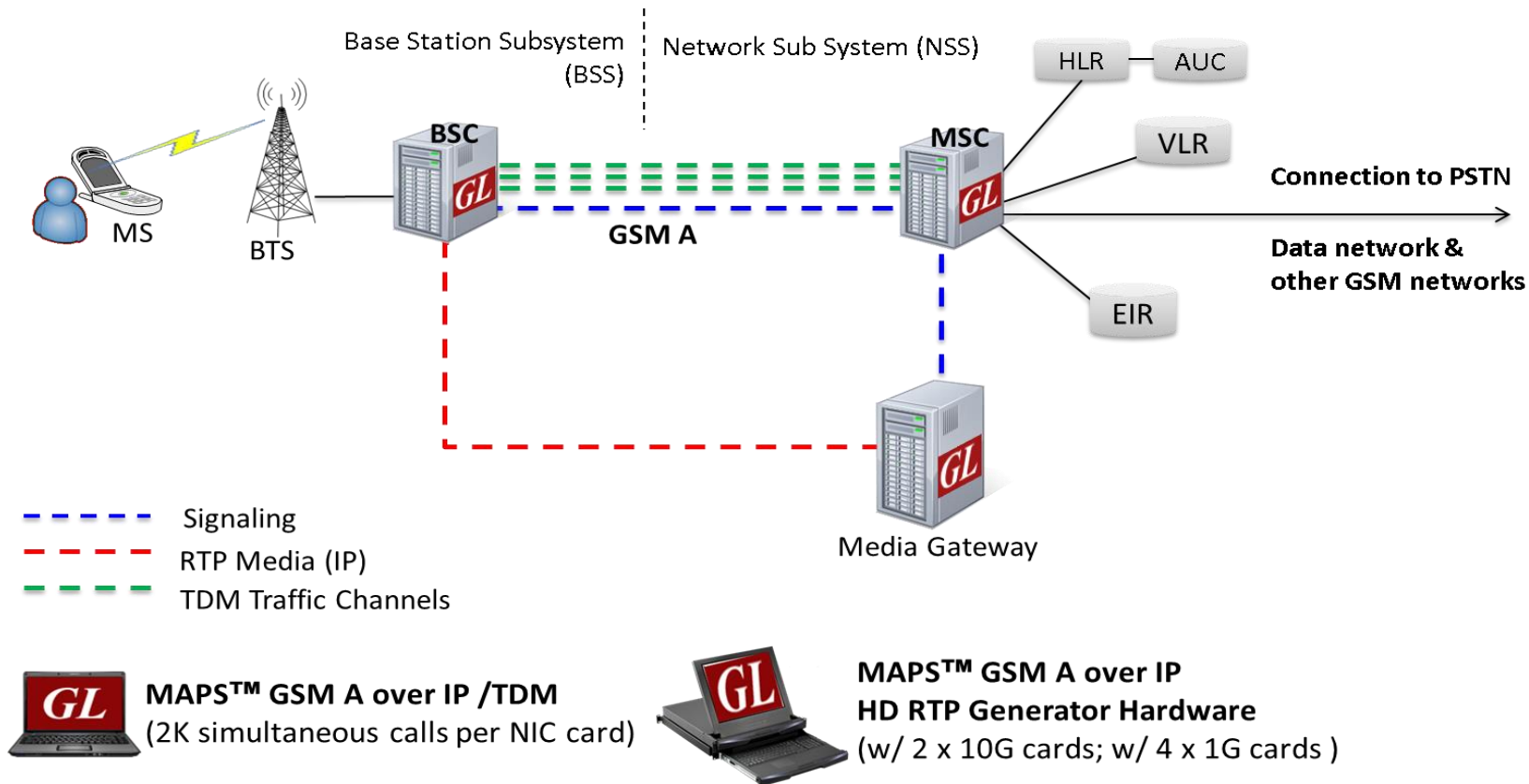

GSMAoIP Mobile Originating Call Flow

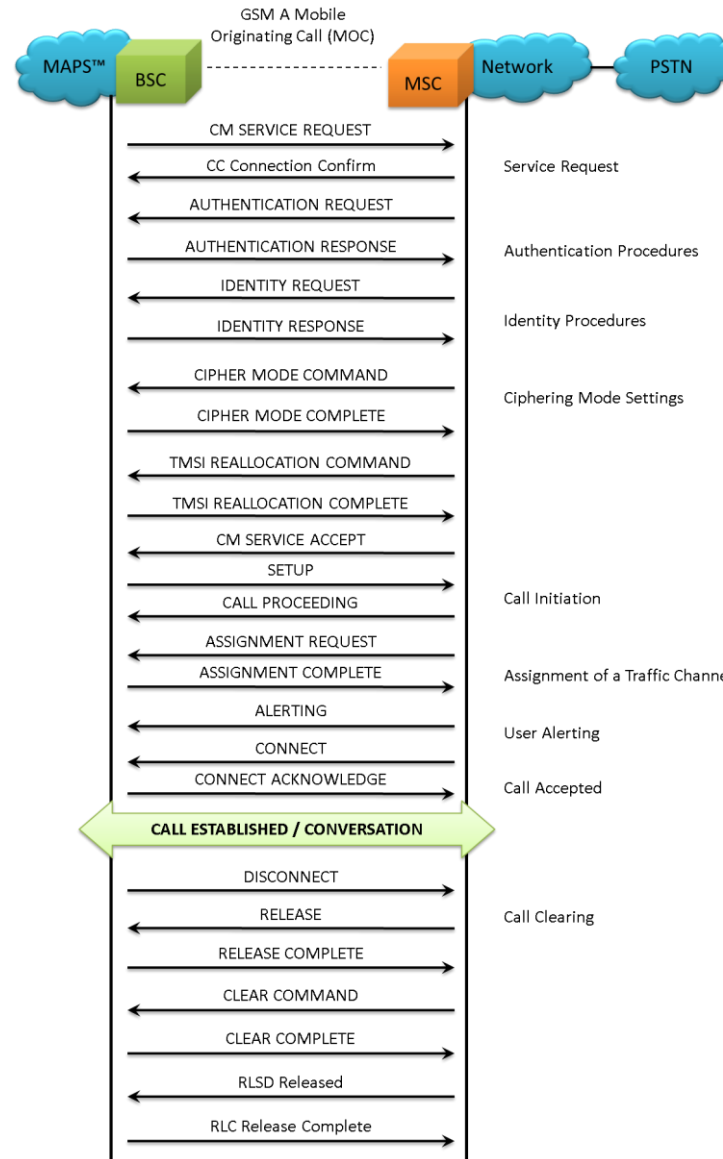

GSMAoIP Mobile Terminating Call Flow

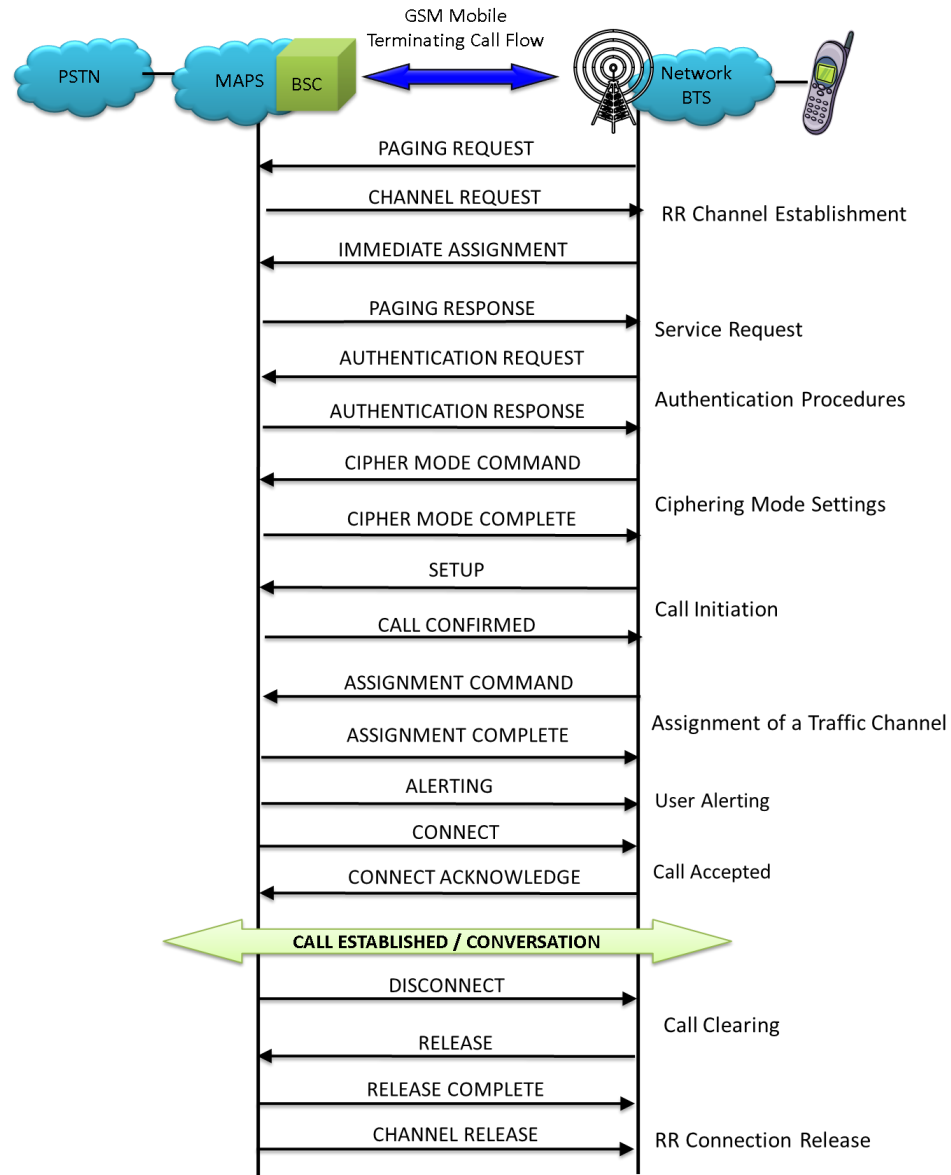

GSMaolP Location Updating Call Flow

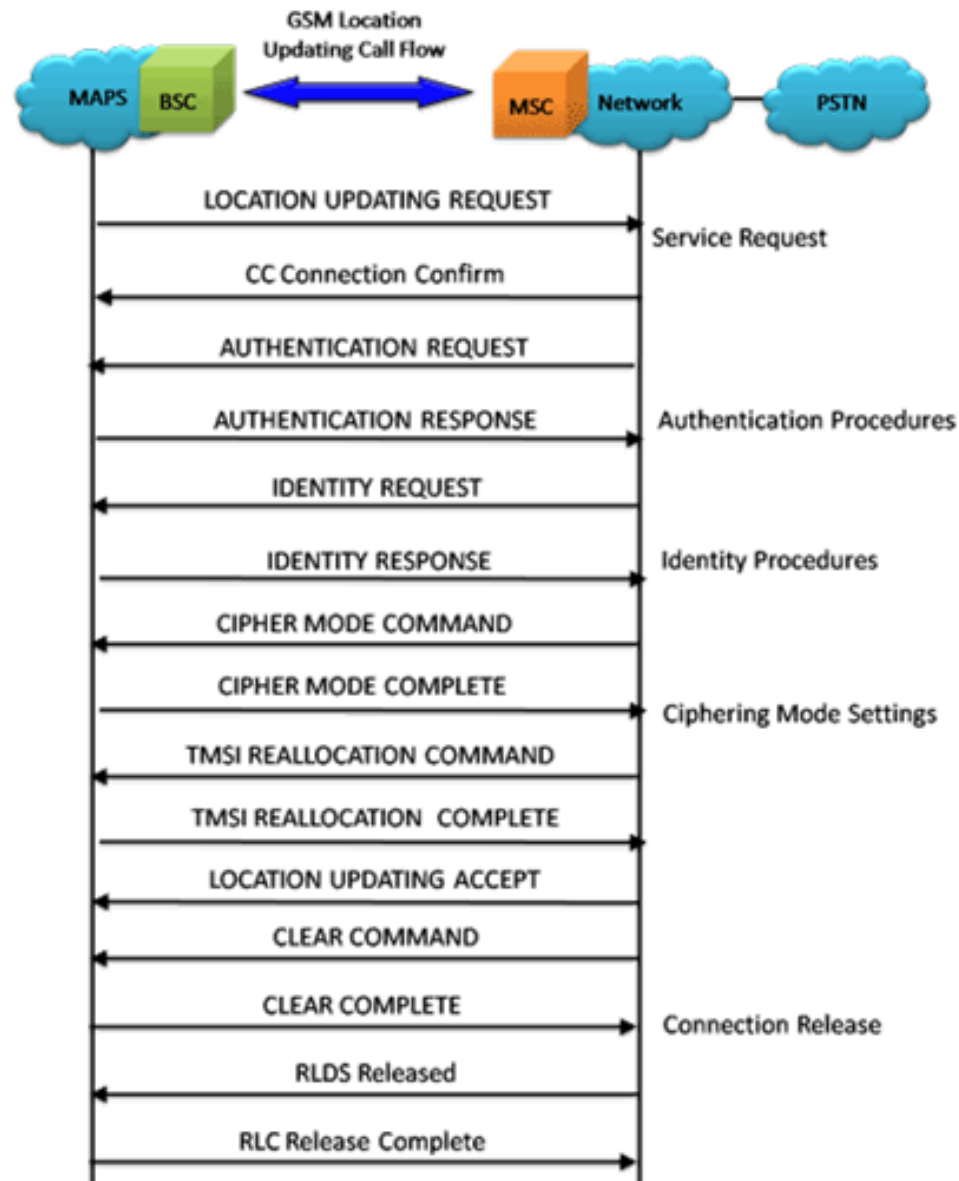

GSMAoIP Supplementary Service Activation Call Flow

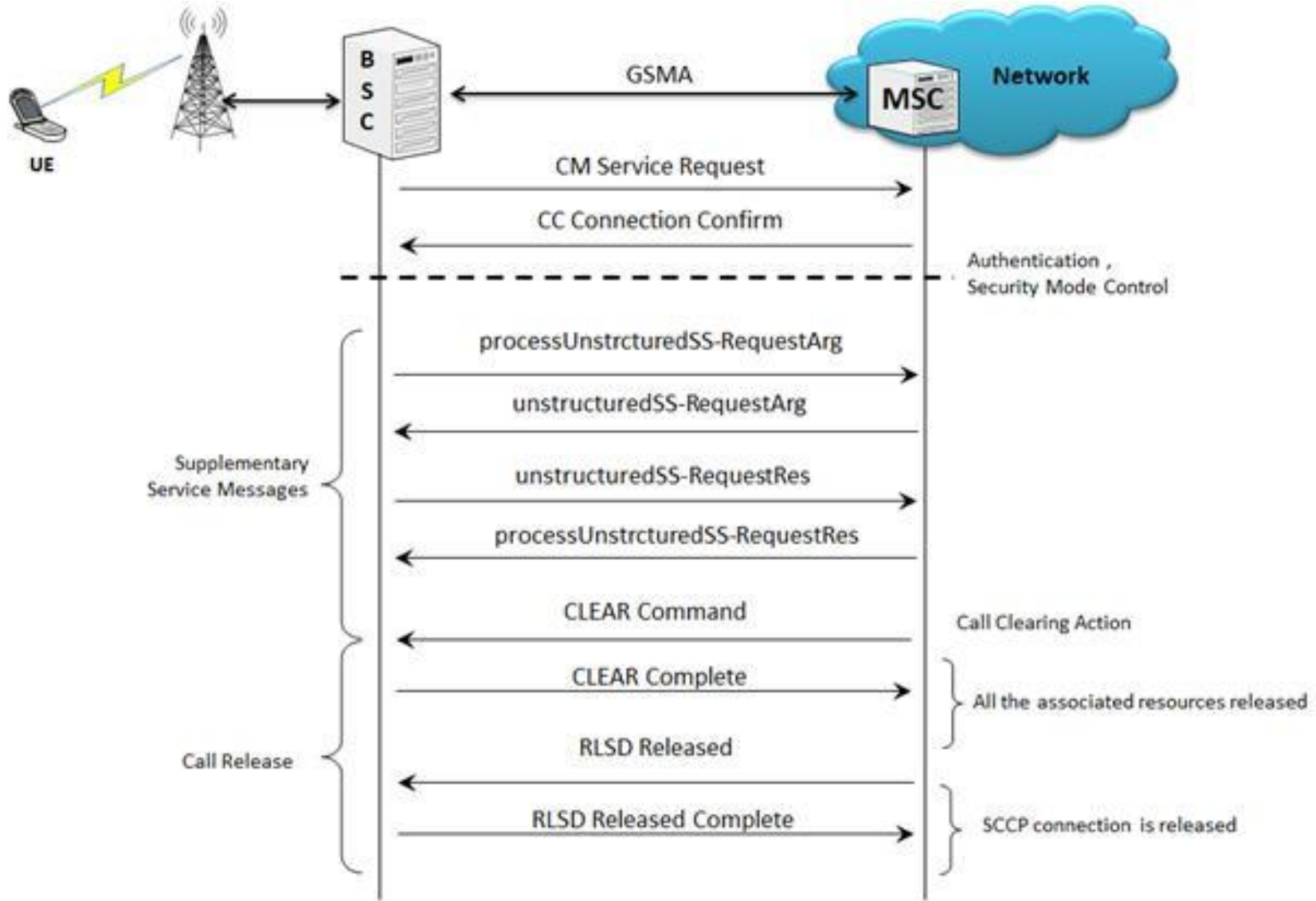

GSMoIP Call Generation

MAPS (Message Automation Protocol Simulation) BSC (GsmAip GSM900 M3UA) - [Call Generation - CallGenDefault]

Configurations Emulator Reports Editor Debug Tools Windows Help

Sl No	Script Name	Profile	Call Info	Script Execution	Status	Events	Events Pt	Result	Total Iterations	Completed Iteratio
1	GSMA_Call.gls	MSPProfile0001	IMSI_901700000000638.TMSI_0x000000	Start	SCCP Connection Released	None		Pass	1	1
2	GSMA_Call.gls	MSPProfile0002	IMSI_901700000000639.TMSI_0x000000	Start	SCCP Connection Released	None		Pass	1	1
3	GSMA_Call.gls	MSPProfile0003		Start		None		Unknown	1	0
4	GSMA_Call.gls	MSPProfile0004		Start		None		Unknown	1	0
5	GSMA_Call.gls	MSPProfile0005		Start		None		Unknown	1	0

Column Width
 Show Latest

Sequence Diagram:

```

sequenceDiagram
    participant BSC
    participant MS
    BSC->>MS: AUTHENTICATION REQUEST 8:18:22.815000
    MS-->>BSC: AUTHENTICATION RESPONSE 8:18:22.816000
    BSC->>MS: CM SERVICE ACCEPT 8:18:22.830000
    MS->>BSC: SMS-SUBMIT 8:18:22.831000
    BSC-->>MS: CPACK 8:18:22.851000
    MS->>BSC: SMS-SUBMIT REPORT 8:18:22.851000
    BSC-->>MS: CPACK 8:18:22.852000
    BSC->>MS: CLEAR COMMAND 8:18:22.871000
    MS-->>BSC: CLEAR COMPLETE 8:18:22.871000
    BSC->>MS: RLSd released 8:18:22.891000
    MS-->>BSC: RLC release complete 8:18:22.891000
          
```

```

***** MTP3 User Adaptation Layer *****
0000 Version = 00000001 Release 1.0
0002 Message Class = 00000001 Transfer
0003 Transfer Message Type = 00000001 Payload Data
0004 Message Length = 80 (x00000050)
      Protocol Data
0008 Tag = x0210 Transfer Protocol Data
000A Length = 70 (x0046)
      Originating Point Code
000E Point Code = 5.5.5(..101000 00101101)
      Destination Point Code
0012 Point Code = 2.2.2(..010000 00010010)
0014 Service Indicator = ....0011 SCCP
0015 Network Indicator = .....00 International network
0016 Message Priority = .....00 Priority Code 0
0017 Signalling Link Selection = 1 (x01)

      Parameter Padding = x0000
***** SCCP Layer *****
0018 Message Type = 00000110 DTI data form 1
      Mandatory Fixed Parameters
      Destination Local Reference Parameter
0019 Destination Local Reference = 7 (x000007)
      Segmenting Reassembling Parameter
          
```

Initialisation Errors
 Error Events
 Captured Errors
 Link Status Up=1 Down=0

GSMoIP Call Reception

MAPS (Message Automation Protocol Simulation) MSC (GsmAlp GSM900 M3UA) - [Call Reception]

Configurations Emulator Reports Editor Debug Tools Windows Help

Sr No	Script Name	Call Info	Script Execution	Status	Events	Event	Results
1	Check_SCTP_Status.gls		Stop	Monitoring SCTP Status	None		Unknown
2	M3UA.gls	1000	Stop	ASP Active	None		Pass
3	SCMG.gls		Stop	Subsystem-Allowed	None		Pass
4	RTP_Stak_Display.gls		Stop		None		Unknown
5	GSMA_Call.gls	IMSI: 901700000000638, TMSI: 0x00000002	Completed	Call Released	None		Pass
6	GSMA_Call.gls	IMSI: 901700000000638, CalledNumber: 90539	Completed	Call Released	None		Fail
7	GSMA_Call.gls	IMSI: 901700000000639, TMSI: 0x00000003	Completed	Call Released	None		Pass
8	GSMA_Call.gls	IMSI: 901700000000689, TMSI: 0x11110034	Stop	Authentication is Successful			Pass
9	GSMA_Call.gls	IMSI: 901700000000689, TMSI: 0x11110034	Stop	Authentication is Successful			Pass
10	GSMA_Call.gls	IMSI: 901700000000638, Calling Number: 90689, IMSI:	Completed	Call Released	None		Pass

Stop Stop All Abort Abort All Show Records Select Active Call Auto Trash Trash Terminate

Save Column Width Show Latest

```

***** NTP3 User Adaptation Layer *****
0000 Version = 00000001 Release 1.0
0002 Message Class = 00000001 Transfer
0003 Transfer Message Type = 00000001 Payload Data
0004 Message Length = 64 (x00000040)
Routing Context =
0008 Tag = x0006 Routing Context
000A Length = 8 (x0008)
000C Routing Context Value = 1 (x00000001)
Protocol Data =
0010 Tag = x0210 Transfer Protocol Data
0012 Length = 45 (x002D)
Originating Point Code =
0016 Point Code = 5.5.5(..101000 00101101)
Destination Point Code =
001A Point Code = 2.2.2(..010000 00010010)
001C Service Indicator = ....0011 SCCP
001D Network Indicator = .....00 International network
001E Message Priority = .....00 Priority Code 0
001F Signalling Link Selection = 1 (x01)
    
```

Scripts Message Sequence Event Config Script Flow Capture Events

● Initialisation Errors ● Error Events ● Captured Errors ● Link Status Up=1 Down=0

MAPS™ GSMA over IP Command Reference Interface (CLI)

MAPS GSMAIP CLI Server

Sample Python Client Script

```
CLI MapsCLI BSC (GsmAlp GSM900 M3UA)
File Edit View
View Latest Command
2:: 2020-3-17 10:27:24.549000 : StartScript 1 "GSM_A_Call.gls" "MSProfile0001" 1 # "CMServiceType"=1,"CalledNumber"=(binarystring)9017000688,"SMDData"="Welcome to CLI","TrafficType"=1
2:: 2020-3-17 10:27:34.616000 : UserEvent 1 "IsTransportUp";
2:: 2020-3-17 10:27:35.706000 : UserEvent 1 "InitiateNewCall";
2:: 2020-3-17 10:27:36.799000 : UserEvent 1 "GetCallStatus";
2:: 2020-3-17 10:27:37.896000 : UserEvent 1 "GetCallStatus";
2:: 2020-3-17 10:27:38.004000 : UserEvent 1 "SendFile" # "TxFileName"="voicefiles\Send\G711\ULAW\Wijay.glw","TxFileDuration"=10;
2:: 2020-3-17 10:28:18.141000 : UserEvent 1 "GetCallStatus";
2:: 2020-3-17 10:28:18.252000 : UserEvent 1 "Terminate";
2:: 2020-3-17 10:28:21.317000 : UserEvent 1 "GetMessageCount";
2:: 2020-3-17 10:28:21.422000 : UserEvent 1 "GetMessageInfo" # "Index"=0;
2:: 2020-3-17 10:28:21.533000 : UserEvent 1 "GetMessageInfo" # "Index"=1;
2:: 2020-3-17 10:28:21.641000 : UserEvent 1 "GetMessageInfo" # "Index"=2;
2:: 2020-3-17 10:28:21.752000 : UserEvent 1 "GetMessageInfo" # "Index"=3;
2:: 2020-3-17 10:28:21.860000 : UserEvent 1 "GetMessageInfo" # "Index"=4;
2:: 2020-3-17 10:28:21.969000 : UserEvent 1 "GetMessageInfo" # "Index"=5;
2:: 2020-3-17 10:28:22.078000 : UserEvent 1 "GetMessageInfo" # "Index"=6;
2:: 2020-3-17 10:28:22.187000 : UserEvent 1 "GetMessageInfo" # "Index"=7;
2:: 2020-3-17 10:28:22.299000 : UserEvent 1 "GetMessageInfo" # "Index"=8;
2:: 2020-3-17 10:28:22.408000 : UserEvent 1 "GetMessageInfo" # "Index"=9;
2:: 2020-3-17 10:28:22.521000 : UserEvent 1 "GetMessageInfo" # "Index"=10;
2:: 2020-3-17 10:28:22.626000 : UserEvent 1 "GetMessageInfo" # "Index"=11;
2:: 2020-3-17 10:28:22.734000 : UserEvent 1 "GetMessageInfo" # "Index"=12;
2:: 2020-3-17 10:28:22.847000 : UserEvent 1 "GetMessageInfo" # "Index"=13;
2:: 2020-3-17 10:28:22.954000 : UserEvent 1 "GetMessageInfo" # "Index"=14;
2:: 2020-3-17 10:28:23.063000 : UserEvent 1 "GetMessageInfo" # "Index"=15;
2:: 2020-3-17 10:28:23.176000 : UserEvent 1 "GetMessageInfo" # "Index"=16;
2:: 2020-3-17 10:28:23.284000 : UserEvent 1 "GetMessageInfo" # "Index"=17;
2:: 2020-3-17 10:28:23.391000 : UserEvent 1 "GetMessageInfo" # "Index"=18;
2:: 2020-3-17 10:28:23.504000 : UserEvent 1 "GetMessageInfo" # "Index"=19;
2:: 2020-3-17 10:28:24.594000 : StopScript 1;
ServerLog:errCode = 0,errString = connection has been gracefully closed for ClientId =2
```

```
Python 3.7.5 Shell
File Edit Shell Debug Options Window Help
GSMMAIP Script Stopping... True
GSMMAIP Server Disconnecting... True
>>>
= RESTART: C:\Program Files\GL Communications Inc\MAPS-GSMAIP\MAPSCLI\PythonClient\examples\BSC\GSMA_PlaceCall.py
GSMMAIP Server Connection... True
GSMMAIP Testbed Starting ... True
GSMMAIP Profile Loading... True
Check M3UA Health Status... True
GSMMAIP Call Initiated... True
Call Status... Connected
Send File started
RTP File Sent
GSMMAIP Call Terminating... True
Total Signalling Messages 20
10:27:35.716 -> CM SERVICE REQUEST
10:27:35.744 <- CC connection confirm
10:27:35.746 <- AUTHENTICATION REQUEST
10:27:35.748 -> AUTHENTICATION RESPONSE
10:27:35.767 <- CIPHER MODE COMMAND
10:27:35.769 -> CIPHER MODE COMPLETE
10:27:35.772 -> SETUP
10:27:35.792 <- CALL PROCEEDING
10:27:35.793 <- ASSIGNMENT REQUEST
10:27:35.796 -> ASSIGNMENT COMPLETE
10:27:35.820 <- ALERTING
10:27:36.836 <- CONNECT
10:27:36.842 -> CONNECT ACKNOWLEDGE
10:28:18.265 -> DISCONNECT
10:28:18.284 <- RELEASE
10:28:18.289 -> RELEASE COMPLETE
10:28:18.306 <- CLEAR COMMAND
10:28:18.310 -> CLEAR COMPLETE
10:28:18.327 <- RLS released
10:28:18.331 -> RLC RELEASE COMPLETE
GSMMAIP Script Stopping... True
GSMMAIP Server Disconnecting... True
>>>
```

GSM Packet Data Analysis (PDA)

Packet Data Analyzer over TDM

- Monitors live TDM networks including capture, analysis, and reporting of every call-in detail. Supported protocols include CAS, ISDN, ISUP, CAMEL, MAP, INAP, and GSM

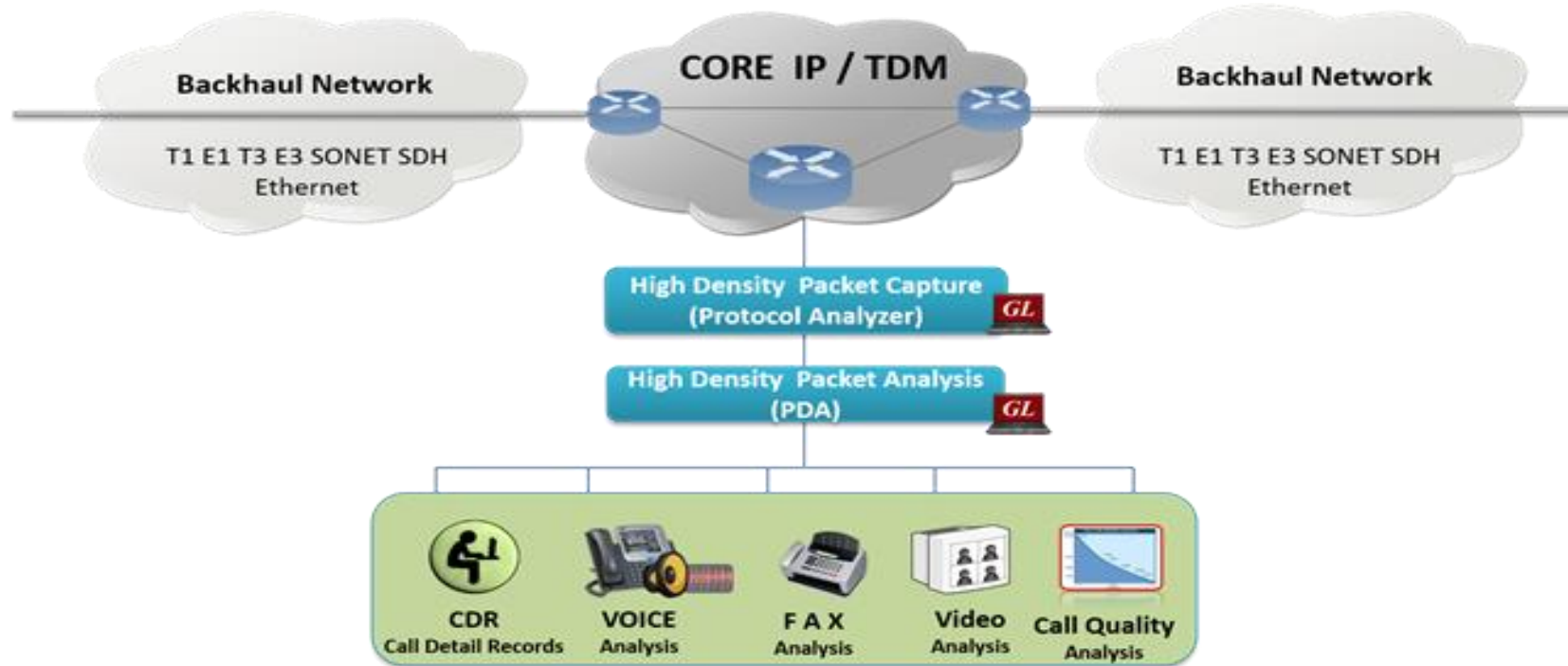

 **GL's Packet Capture Module**
PacketScan, LightSpeed1000, T1 E1 T3 E3 Analyzer Pods

 **GL's Packet Analysis Module**
H.323, LTE, IMS, SIP, MGCP, MEGACO, UMTS, GPRS, GSM A, BICC, CAP, MAP, SIGTRAN

Main Features

<p>CDR, Call Flow, Statistics, and Report Generation</p>	<ul style="list-style-type: none"> • Isolates call specific information for each individual call from the captured data and displays the information in an organized fashion • A host of call and message counters gives the user an instantaneous snapshot of the traffic on the network • Pictorial representation of the statistics including ladder diagrams for the calls of various protocols • Ability to export and analyze call detail records of completed calls in CSV file format. • These reports can be further fed to DB and accessed using GL's NetSurveyorWeb™ Lite for analysis • Isolates calls, a graphical call flow diagram can be created from a call trace • Filters on CDR information feature is used to search required calls by using "key" as CDR parameters • Event counters on CDR information provides over all count of completed events such as total calls, active calls, completed calls, purged calls, failed calls, calls per second, remaining calls and more • Flexible options are provided to interchange/hide the columns as required
<p>Traffic Recording</p>	<ul style="list-style-type: none"> • Supports capturing of voice, digits, tones and FAX etc. to *.PCM file format
<p>Triggers and Actions</p>	<ul style="list-style-type: none"> • Filter captures based on protocol parameters such as OPC, DPC or CIC in case of ISUP followed by a set of actions such as save call, send mail, trigger alarm notification etc. for the completed calls
<p>Exporting Calls</p>	<ul style="list-style-type: none"> • Supports saving the selected calls from traffic analyzer into *.HDL, *.PCAP, or *.PCAPNG formats

Data Link Group

GSMA CIC Mapping ✕

File

Device Selection

East West

Point Codes

OPC DPC

Circuit Group Configuration

CIC Quantity CIC Start Timeslot Start

Skip TS16 CIC Numbering

OPC	DPC	CIC Start	CIC Quantity	East	West	TimeSlot Start	
1.1.1	2.2.2	1	31	1	2	1	
1.1.1	2.2.2	32	31	3	4	1	
1.1.1	2.2.2	63	31	5	6	1	
1.1.1	2.2.2	94	31	7	8	1	

Traffic Recording Configurations

Traffic Recording Configuration ✕

File

Recording (Non Segmented)

Directory

Record Duration sec {0 to Record Entire Call Duration}

Include Absolute Path in CDR

Segmented Recording

Directory

No. of Segments Segment Length sec

Max Simultaneous Recordings

Create Subfolder Every min

GSMA Call Summary

Active Call Graph

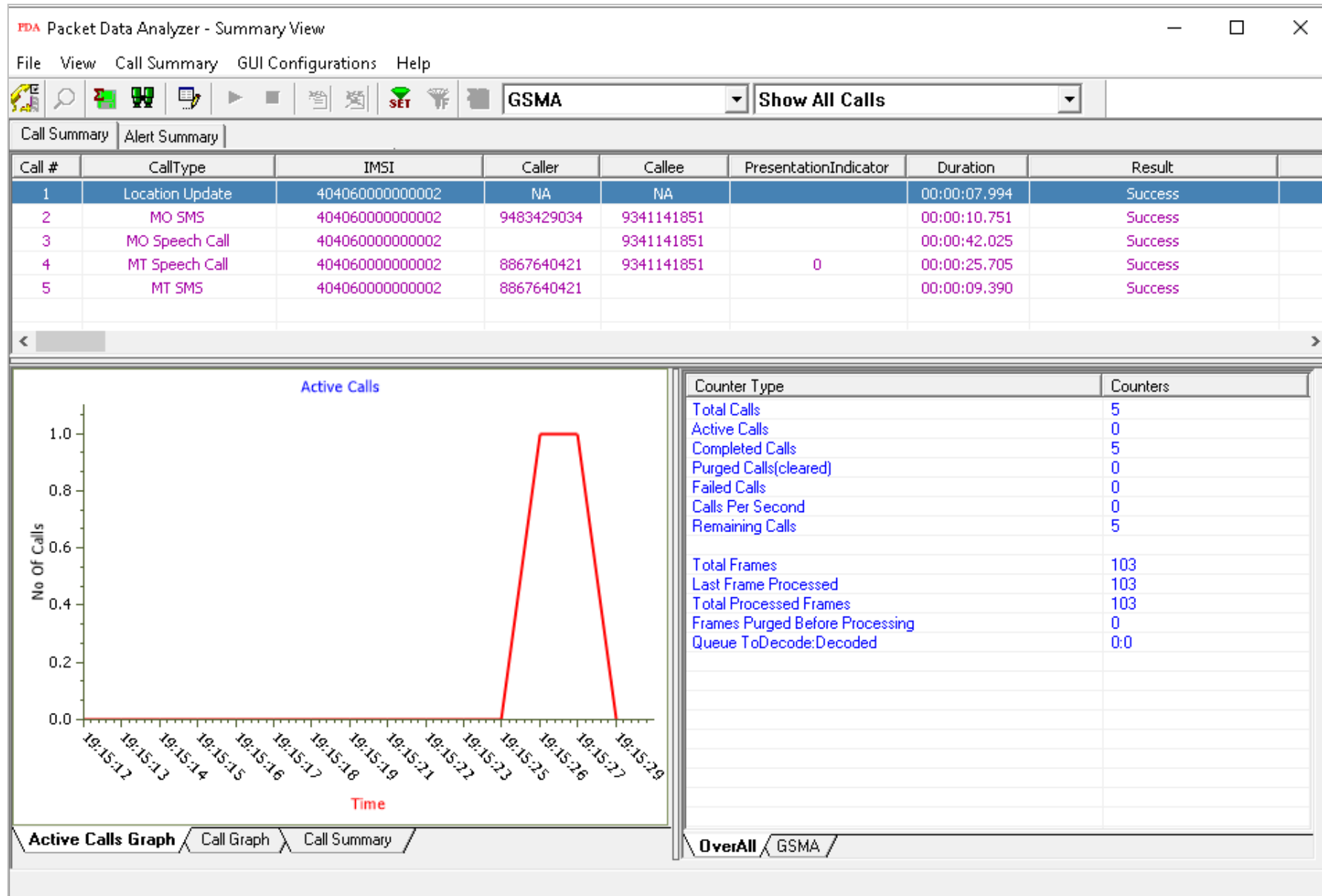

Summary View

Packet Data Analyzer - Summary View

File View Call Summary GUI Configurations Help

GSMA Show All Calls

Call Summary Alert Summary

Call #	CallType	IMSI	Caller	Callee	PresentationIndicator	Duration	Result
1	Location Update	404060000000002	NA	NA		00:00:07.994	Success
2	MO SMS	404060000000002	9483429034	9341141851		00:00:10.751	Success
3	MO Speech Call	404060000000002		9341141851		00:00:42.025	Success
4	MT Speech Call	404060000000002	8867640421	9341141851	0	00:00:25.705	Success
5	MT SMS	404060000000002	8867640421			00:00:09.390	Success

Column Width

TimeStamp	Frame Number	1.1.1	
00.00.000	0	1:23	Location Updating Request
00.00.671	1	1:23	← CC connection confirm
00.00.674	2	1:23	← Authentication Request
00.01.349	3	1:23	Authentication Response
00.02.012	4	1:23	← CIPHER MODE COMMAND
00.02.664	5	1:23	CIPHER MODE COMPLETE
00.03.323	6	1:23	← Identity Request
00.03.987	7	1:23	Identity Response
00.04.652	8	1:23	← TMSI Reallocation Command
			TMSI Reallocation Complete

Find

```

===== MTP2 Layer =====
BSN = .0100011 (35)
BIB = 1..... (1)
FSN = .0100001 (33)
FIB = 1..... (1)
LI = ..110100 MSU Fo
===== MTP3 Layer =====
Service Indicator = ....0011 SCCP
Priority Code = ..00.... Priori
Sub-service field = 10..... Nation
DPC = 2.2.2(00010010
OPC = 1.1.1(01.....
Signalling Link Code = 0001.... (1)
===== SCCP Layer =====
Message Type = 00000001 CR con
Mandatory Fixed Parameters =
Source Local Reference Parameter =
Source Local Reference = 262144 (hex 040
Protocol Class Parameter =
Class = ....0010 (2)
Message Handling (Class 0 and 1 only) = 0000.... No Spe
    
```

Active Calls Graph Call Graph Call Summary

Call Summary - Signaling Parameters

PDA Packet Data Analyzer - Summary View

File View Call Summary GUI Configurations Help

GSMA Show All Calls

Call Summary Alert Summary

Call #	CallType	IMSI	Caller	Callee	PresentationIndicator	Duration	Result
1	Location Update	404060000000002	NA	NA		00:00:07.994	Success
2	MO SMS	404060000000002	9483429034	9341141851		00:00:10.751	Success
3	MO Speech Call	404060000000002		9341141851		00:00:42.025	Success
4	MT Speech Call	404060000000002	8867640421	9341141851	0	00:00:25.705	Success
5	MT SMS	404060000000002	8867640421			00:00:09.390	Success

Signalling Parameters

Parameter	Value
Caller	NA
Callee	NA
CallId	1
Call Status	Terminated
Call Initiated Time	2013-10-22 19:10:30.291
Call Established Time	2013-10-22 19:10:36.293
Call Stop Time	2013-10-22 19:10:38.286
Call Duration	00:00:01.992
Call Terminator	
Call Failure Reason	
Total Signaling Frames	15

Active Calls Graph Call Graph **Call Summary**

Triggers and Action Settings

Save Call to File

- Allows the users to save the filtered files either in *.HDL, *.PCAP, or *.PCAPNG format

The image shows a software dialog box titled "Action". On the left, there is a list of actions with checkboxes: "Save Call" (checked), "Audio Recording", "User Defined", "Send e-mail", "Alert Summary", "Call Detail Record", and "Extract Fax Image". The main area is divided into three sections:

- Save Call To File Options:** Contains a "File Name Mask" text box with the value "%I_%Y_%M_%D_%h-%m-%s" and a "Files Destination Directory" text box with the value "C:\Program Files\GL Communicatic" and a browse button.
- Save Options:** Contains three radio buttons: "HDL File" (selected), "PCAP File", and "PCAPNG". Below them is a "Link Type" text box with the value "0" and a "Call Summary" checkbox.
- Create File Options -- If File Exists:** Contains three radio buttons: "Overwrite" (selected), "Skip Operation", and "Append Sequence Number".

Audio Recording

- Allows to save the filtered files as the voice files in *.wav format

The screenshot shows a dialog box titled "Action" with a list of actions on the left and "Audio Recording Options" on the right. The "Audio Recording" action is selected. The options include a file name mask, a destination directory, audio mixing options, and file creation options.

Action

- Save Call
- Audio Recording
- User Defined
- Send e-mail
- Alert Summary
- Call Detail Record
- Extract Fax Image

Audio Recording Options

Audio File Name Mask
%l_%Y_%M_%D_%h-%m-%s.wav

Audio Files Destination Directory
\\GL Communications Inc\ ...

Audio Mixing Options

Mix Stereo To Separate Wave File

Create File Options -- If File Exists

Overwrite Skip Operation Append Sequence Number

Send e-mail

- With this option, the Packet Data Analyzer sends an e-mail containing useful information about each filtered call

The screenshot shows a configuration window for the Packet Data Analyzer. On the left, under the 'Action' section, a list of options is shown with checkboxes: 'Save Call', 'Audio Recording', 'User Defined', 'Send e-mail', 'Alert Summary', 'Call Detail Record', and 'Extract Fax Image'. The 'Send e-mail' option is checked and highlighted. To the right, there are three sub-sections: 'Audio Recording Options' with a text field for 'Audio File Name Mask' containing '%I_%Y_%M_%D_%h-%m-%s.wav' and a text field for 'Audio Files Destination Directory' containing '\\GL Communications Inc\' with a browse button; 'Audio Mixing Options' with radio buttons for 'Mix' (selected), 'Stereo', and 'To Separate Wave File'; and 'Create File Options -- If File Exists' with radio buttons for 'Overwrite' (selected), 'Skip Operation', and 'Append Sequence Number'.

Alert Summary

- This option allows the user to set the alarm type and alarm message for the selected triggering type

Action

<input checked="" type="checkbox"/> Save Call	Alarm Type	Warning
<input type="checkbox"/> Audio Recording		
<input type="checkbox"/> User Defined	Alarm Message	Triggers at the specified value
<input type="checkbox"/> Send e-mail		
<input checked="" type="checkbox"/> Alert Summary		
<input type="checkbox"/> Call Detail Record		
<input type="checkbox"/> Extract Fax Image		

Alert Summary

FDA Packet Data Analyzer - Summary View

File View Help



Call Summary Alert Summary

Call#	Protocol	Message	Type	Threshold	Value	Caller	Callee	Callid
2	GSMA	Callee Number	Critical	9341141851	9341141851	9483429034	9341141851	2
3	GSMA	Callee Number	Critical	9341141851	9341141851		9341141851	3
4	GSMA	Callee Number	Critical	9341141851	9341141851	8867640421	9341141851	4

Call Detail Record (CDR)

- With this option, the Packet Data Analyzer can output call detail records (CDR) in the form of three Comma Separated Value (CSV) files such as Call Side Record, Call Master Record, and Call Events

Action

<input checked="" type="checkbox"/> Save Call	<input checked="" type="checkbox"/> Call Side Record	Probe Name	<input type="text" value="TDMProbe"/>
<input checked="" type="checkbox"/> Audio Recording	<input checked="" type="checkbox"/> Call Master Record		
<input checked="" type="checkbox"/> User Defined	<input checked="" type="checkbox"/> Call Events Record		
<input checked="" type="checkbox"/> Send e-mail			
<input checked="" type="checkbox"/> Alert Summary			
<input checked="" type="checkbox"/> Call Detail Record			
<input checked="" type="checkbox"/> Extract Fax Image			

CSV Files Destination Directory

...

Use Sub Folders

Folder Prefix Create Subfolder Every hr

Create File Options -- If File Exists

Overwrite Skip Operation Append Sequence Number

Load or Save Configurations

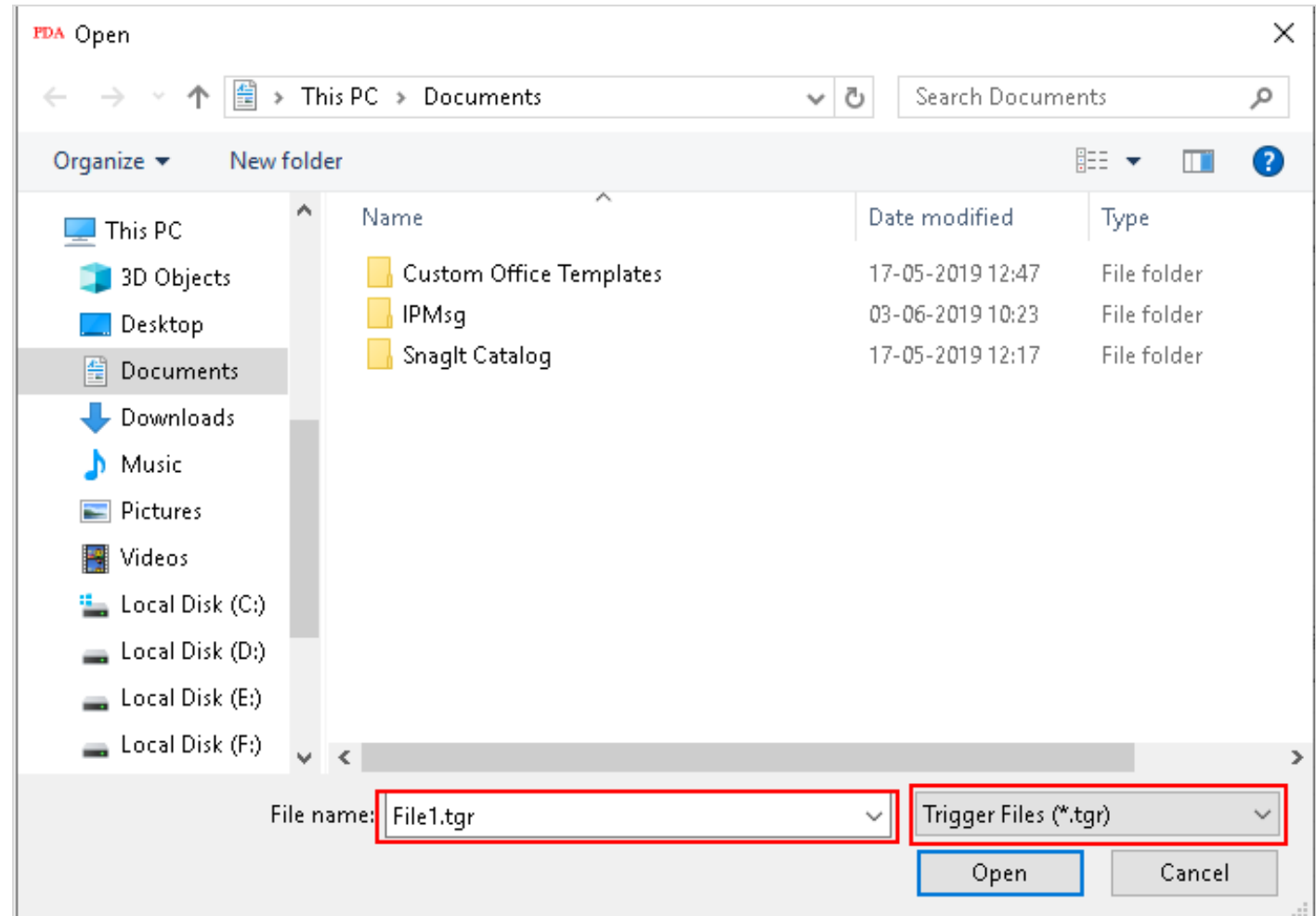
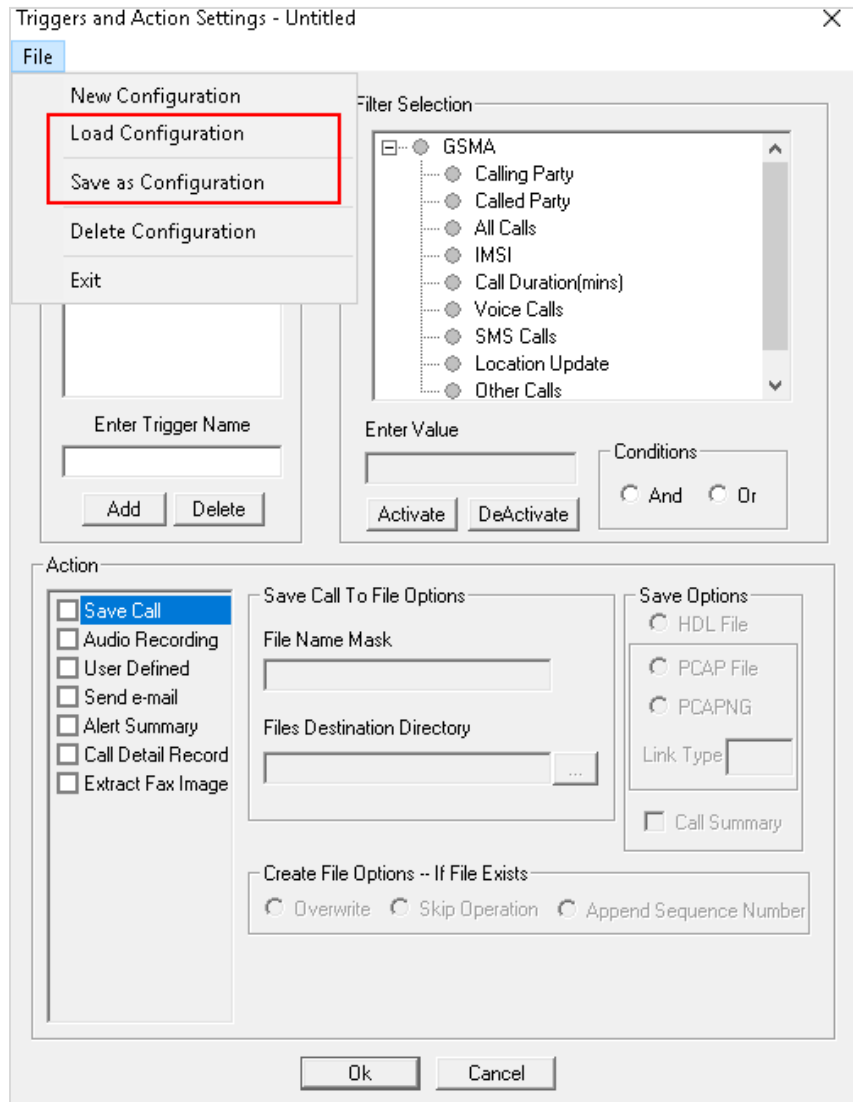

PDA Startup Options

- Allows user to configure start-up tasks which will be started automatically whenever PDA is launched
- Loads the selected Triggers and Actions profile while invoking PDA

PDA Startup Options

Execute Tasks On PDA Startup

Startup Tasks

Enable Triggers And Actions

Triggers And Actions Profile

C:\Program Files\GL Communications Inc\tScar ...

Select Protocol GSMA

Enable CSV

CSV Export Profile

C:\Program Files\GL Communications Inc\tScar ...

Thank You