

# MAPS™ 5G N17 Interface Emulator

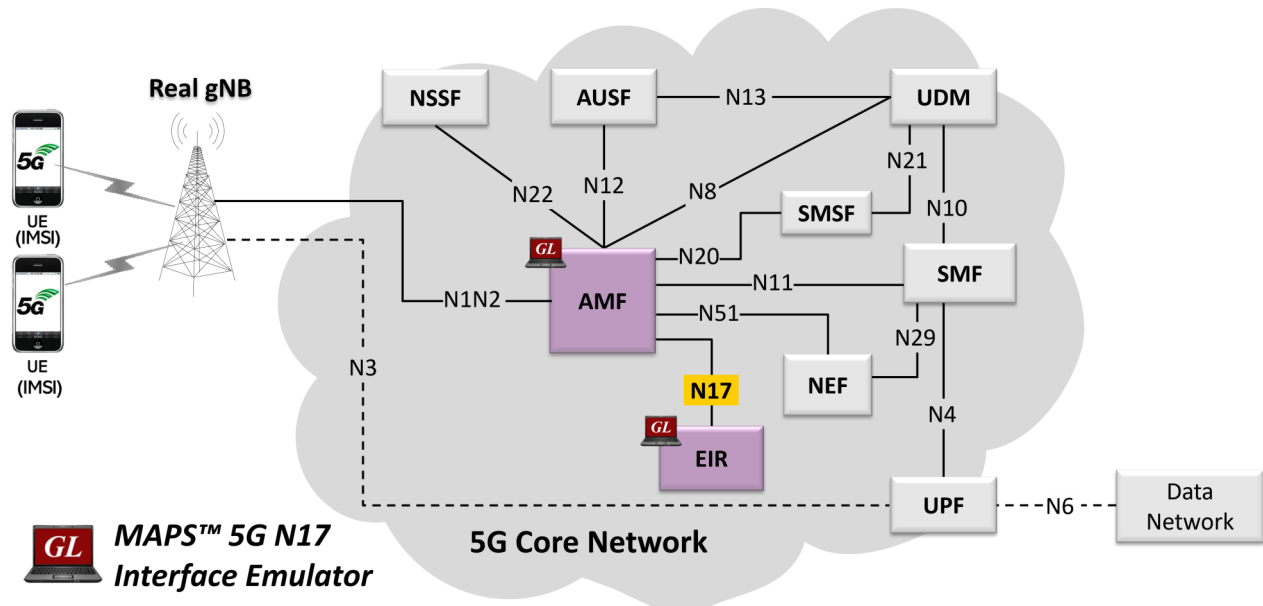

## Overview

5G System as a service-based architecture, includes a set of Network Functions (NFs) providing services as defined in 3GPP TS 23.501. The service-based interfaces use HTTP/2 protocol with JavaScript Object Notation (JSON) as the application layer serialization protocol.

GL's MAPS™ emulates Equipment Identity Register (EIR) within the 5G core offering services to the Access and Mobility Management Function (AMF) via the N5g-eir service based N17 interface. The figure represents the service based interfaces, with focus on the EIR and AMF.

The EIR and AMF support N5g-eir\_EquipmentIdentityCheck Service. In N17 interface, EIR acts as NF Service Producer and AMF acts as NF Service Consumer as per N5g-eir specifications 3GPP TS 29.511.

Besides emulating EIR and AMF, it also supports error tracking, regression testing, load testing. It can run pre-defined test scenarios against 5G interface test objects in a controlled and deterministic manner. Easy to use script syntax allows user to create conformance test cases based on their test plan.

MAPS™ 5G N17 emulator supports powerful utilities such as Script Editor and Profile Editor which allows new scenarios to be created or existing scenarios to be modified using messages and parameters.

For more information, refer to [MAPS™ 5G N17 Interface Emulator](#) webpage.

## Main Features

- Emulates EIR and AMF network elements
- Supports Equipment Identity services via the N5g-eir service based N17 interface
- Services use REST APIs based on HTTP and JSON data format
- Supports TLS and TCP transports
- Supports scripted call generation and automated call reception
- Supports customization of call flow and message templates using Script Editor
- Ready-to-use scripts for quick testing
- Provides Call Statistics and Events Status
- Emulates Multiple Subscribers using CSV Profiles
- Automation, Remote access, and Schedulers to run tests 24/7



818 West Diamond Avenue - Third Floor, Gaithersburg, MD 20878, U.S.A  
(Web) [www.gl.com](http://www.gl.com) - (V) +1-301-670-4784 (F) +1-301-670-9187 - (E-Mail) [info@gl.com](mailto:info@gl.com)

## Testbed Configuration

The testbed setup window allows user to setup the required test configurations in N17 interface. It includes a list of variables that are declared and assigned before starting the script. Testbed Setup defines the MAPS™ parameters which communicates with the rest of the test network. End user configuration profile is used to configure MAPS™ 5G N17 interface with the supported AMF and EIR parameters.

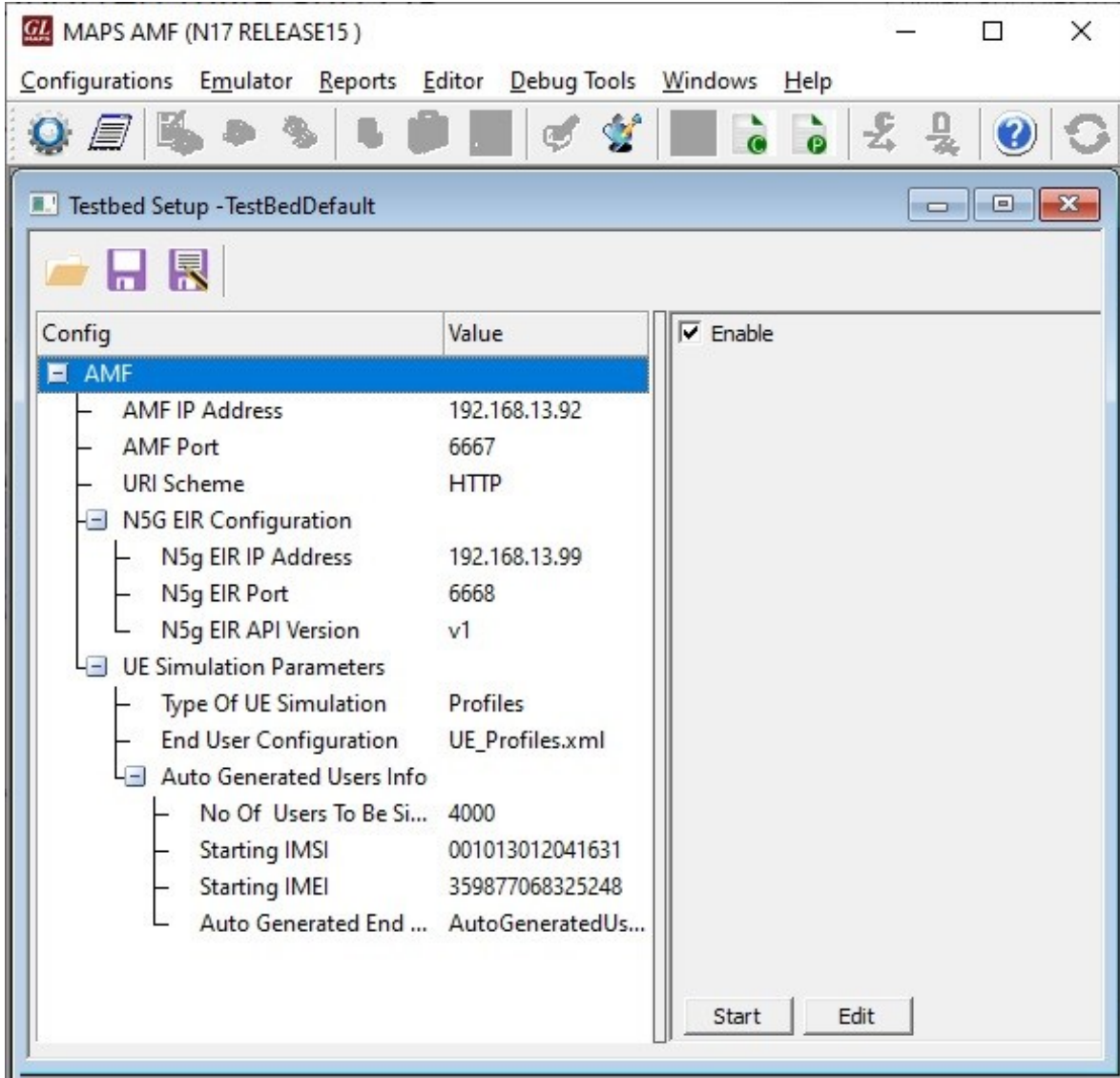

Figure: Testbed Setup

## Pre-processing Tools

**SCRIPT EDITOR** - The script editor allows user to create/edit scripts and access protocol fields as variables for the message template parameters. The script uses pre-defined message templates, to perform send and receive actions.

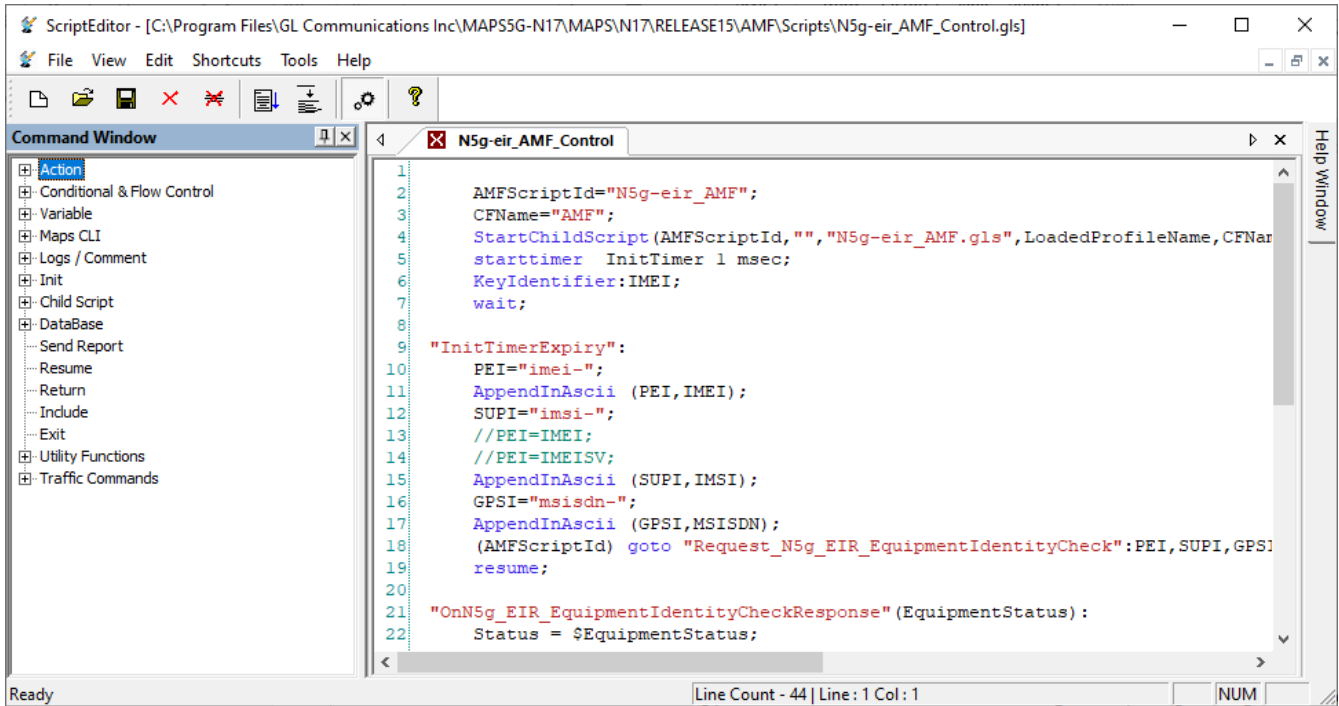

Figure: Script Editor

**PROFILE EDITOR** - This feature allows loading profile to edit the values of variables using GUI, replacing the original value of variables in the message template. An XML file defines a set of multiple profiles with varying parameter values which allows users to configure call instances in call generation to receive calls. The UE\_Profiles includes 5G parameters which is required to configure multiple UEs to emulate Signaling and Traffic.

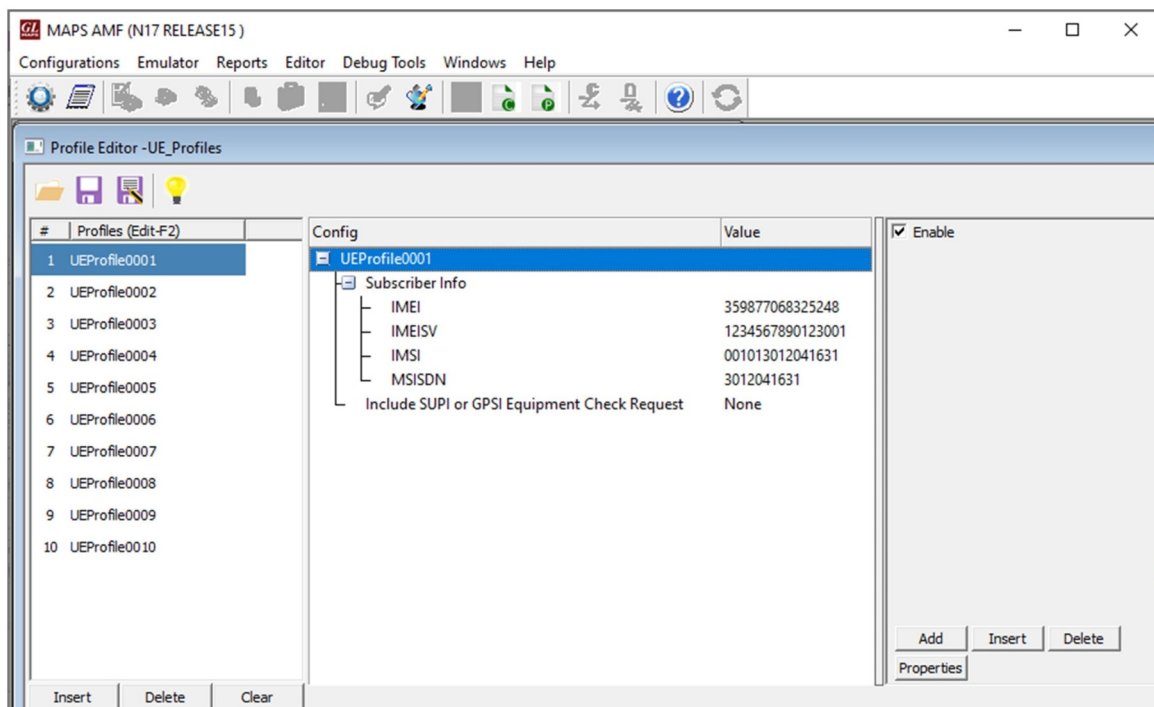

Figure: Profile Editor

## Call Generation and Reception

In call generation mode, MAPS™ is configured for the outgoing messages, while in call receive mode, it is configured to respond to the incoming messages. Tests can be configured to run once, multiple iterations and continuously. Also, allows users to create multiple entries using quick configuration feature.

The editor allows to run the added scripts sequentially (order in which the scripts are added in the window) or randomly (any script from the list of added script as per the call flow requirements). The test scripts are started manually at call generation, and at the call reception, the script is automatically triggered by incoming messages.

Sr...	Script Name	Profile	Call Info	Script Execution	Status	Events	Events Profile	Result	Total Iterations	Completed..
1	N5g-eir_AMF_Control.gls	UEProfile0001	359877068325248	Start	WHITELISTED	None		Pass	1	1
2	N5g-eir_AMF_Control.gls	UEProfile0002	359877068325249	Start	WHITELISTED	None		Pass	1	1

```

Status: 200
:status : 200
content-type : application/json
content-length : 24
{
  "status": "WHITELISTED"
}
  
```

Figure: Call Generation

Sr No	Script Name	Profile	Call Info	Script Execution	Status	Events	Events Profile	Results
1	N5g-eir_Control.gls		imei-359877068325248	Completed	WHITELISTED	None		Pass
2	N5g-eir_Control.gls		imei-359877068325249	Completed	WHITELISTED	None		Pass

```

Status: 200
content-type : application/json
{
  "status": "WHITELISTED"
}
  
```

Figure: Call Reception

## N5g-EIR\_EquipmentIdentityCheck Service

MAPS™ for N17 interface emulates services between EIR and AMF network functions. MAPS™ supports N5g-eir to check the Permanent Equipment Identifier (PEI) status of the subscribers if it is blacklisted, grey listed, or whitelisted. The PEI is obtained from the UE during the initial registration.

In this procedure, the AMF sends a request to EIR to check the equipment status through PEI using the HTTP GET method, and determine the subscriber is allowed to use the equipment or not.

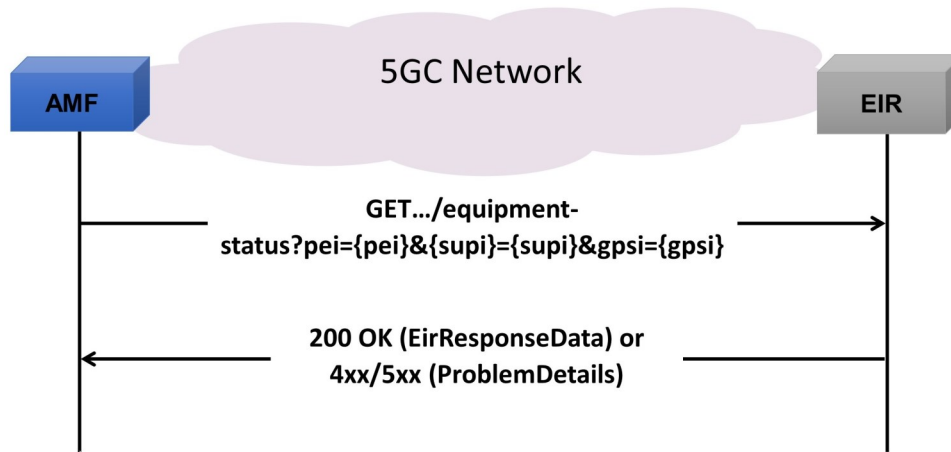

- AMF sends a GET request to the EIR access to check the equipment status of subscribers
- On success, "200 OK" the Equipment status of the subscriber is returned
- If the PEI is not known the EIR responds with HTTP Status Code "404 Not Found" and the problem error message "ERROR\_EQUIPMENT\_UNKNOWN" is returned
- When receiving the response from the EIR, the NF Service Consumer (AMF) shall check the equipment Status and the detailed problem. Depending upon the result, the NF Service Consumer will decide its subsequent actions (e.g. sending a Registration Reject if the 5G-EIR indicates that the PEI is unknown or blacklisted)

## Supported Protocols and Specifications

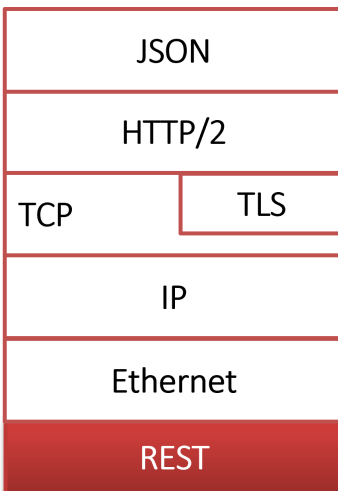

Supported Protocol	Standard/ Specification
N17 Interface (EIR)	3GPP TS 29.511 V17.2.0
JavaScript Object Notation (JSON)	IETF RFC 8259
HTTP/2	IETF RFC 7231 IETF RFC 7540/RFC 7541
TLS	IETF RFC 8446
TCP	IETF RFC 793
IPv4	IETF RFC 791 IETF RFC 2460

## Supported Protocols and Specifications

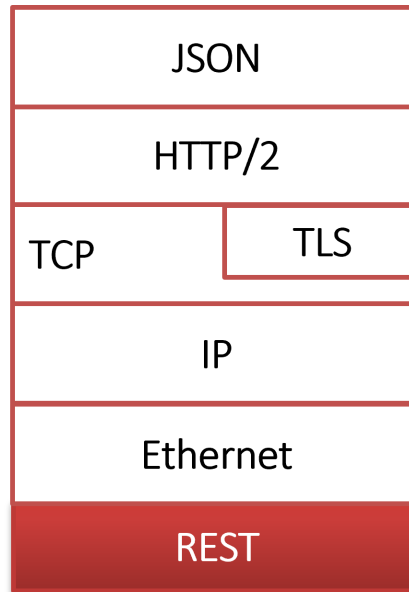

Supported Protocol	Standard/ Specification
N17 Interface (EIR)	3GPP TS 29.511 V17.2.0
JavaScript Object Notation (JSON)	IETF RFC 8259
HTTP/2	IETF RFC 7231 IETF RFC 7540/RFC 7541
TLS	IETF RFC 8446
TCP	IETF RFC 793
IPv4	IETF RFC 791 IETF RFC 2460

## Buyer's Guide

Item No	Product Description
<a href="#">PKS502</a>	MAPS™ 5G N17 Interface Emulator (Prerequisite base license for all service-based (Open API) interface emulations)
<a href="#">PKS305</a>	MAPS™ 5G multi-Interface Emulator

Item No	Related Software
<a href="#">PKS500</a>	MAPS™ 5G N1/N2 Interface Emulator
<a href="#">PKS501</a>	MAPS™ 5G N4 Interface Emulator
<a href="#">PKS503</a>	MAPS™ 5G N8 Interface Emulator (Requires PKS502)
<a href="#">PKS504</a>	MAPS™ 5G N10 Interface Emulator (Requires PKS502)
<a href="#">PKS505</a>	MAPS™ 5G N11 Interface Emulator (Requires PKS502)
<a href="#">PKS506</a>	MAPS™ 5G N12 Interface Emulator (Requires PKS502)
<a href="#">PKS507</a>	MAPS™ 5G N20 Interface Emulator (Requires PKS502)
<a href="#">PKS508</a>	MAPS™ 5G N20 Interface Emulator (Requires PKS502)
<a href="#">PKS509</a>	MAPS™ 5G N21 Interface Emulator (Requires PKS502)
<a href="#">PKS510</a>	MAPS™ 5G N22 Interface Emulator (Requires PKS502)
<a href="#">PKS511</a>	MAPS™ 5G N29 Interface Emulator (Requires PKS502)
<a href="#">PKS511</a>	MAPS™ 5G N51 Interface Emulator (Requires PKS502)

For complete list of MAPS™ products, refer to [Message Automation & Protocol Simulation \(MAPS™\)](#) webpage.

For more details on supported MAPS™ 5G interfaces, refer to [5G Core \(5GC\) Network Test Solution](#) webpage.



818 West Diamond Avenue - Third Floor, Gaithersburg, MD 20878, U.S.A  
 (Web) [www.gl.com](http://www.gl.com) - (V) +1-301-670-4784 (F) +1-301-670-9187 - (E-Mail) [info@gl.com](mailto:info@gl.com)