

MAPS™ FXO FXS

(Automated Analog Terminal (FXO) and Network Port (FXS) Testing)

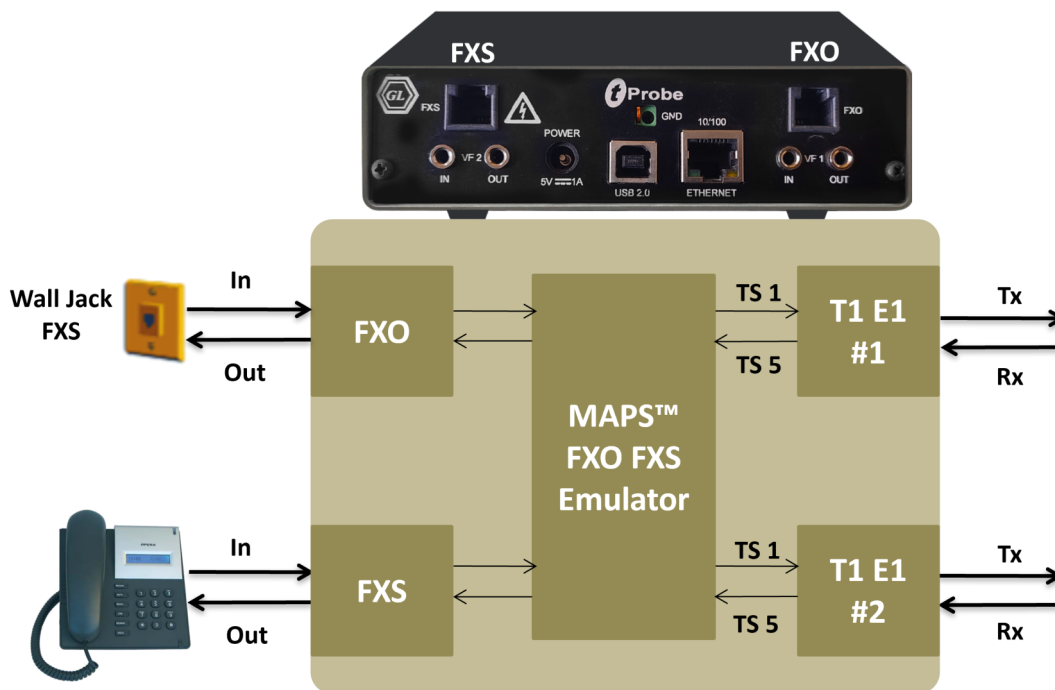

Overview

Foreign Exchange Subscriber (FXS) and Foreign Exchange Office (FXO) are ports used by analog phone lines or phones. A FXS port supplies ring voltage, battery current, dial tone and voice signals. FXO delivers an on-hook/off-hook indication (loop closure), DTMF digits, voice signals, and is usually a phone or fax machine.

The FXO and FXS ports on [tProbe™](#) simulates all of the above features. Also, the FXO port on the tProbe™ permits non-intrusive capture and analysis of voice-band signals from a two-wire telephone line. The FXS port on tProbe™ emulates a 2-Wire FXS service such as a telephone wall jack.

GL's [Message Automation & Protocol Simulation \(MAPS™\)](#) platform is a general purpose protocol emulator tool for various protocols encountered in the telecom space. MAPS™ FXO FXS is an advanced test tool that supports emulation of FXO and FXS ports on a tProbe™. MAPS™ provides a facility to place call/answer incoming call on both FXO and FXS ports, and automate the entire testing process using scripts.

Supports simulation of [CAMA](#) trunks connected to the 911 selective router (SR) and can be configured for non-intrusive monitoring of 911 services.

MAPS™ FXO FXS Emulator includes features to handle different types of traffic such as tones, digits (DTMF, MF, MFR2F, MFR2B), voice files, fax, and more. Also, simulate various FXO FXS test scenarios using tProbe™ Client Server scripts. Windows Client Server (WCS) scripts used with tProbe™ analyzer can perform basic operation such as setup calls, receive calls, monitor signaling, and handle traffic.

For more information, refer to [Automated Analog Terminal \(FXO\) and Network Port \(FXS\) Testing](#) webpage.



818 West Diamond Avenue - Third Floor, Gaithersburg, MD 20878, U.S.A
(Web) www.gl.com - (V) +1-301-670-4784 (F) +1-301-670-9187 - (E-Mail) info@gl.com

Main Features

- Script based simulation of 2-Wire Telephone Port (FXO) and Telephone Wall Jack (FXS)
- Standalone testing of FXO/FXS with loopback
- Supports input and output signals of 8K samples/sec, u-law, A-law, and 16-bit Linear PCM
- FXO Capabilities
 - ON hook and OFF hook (loop closure)
 - Transmit and Capture Traffic (Digits, Tones, and Voice)
 - 2-Wire Calling/Answering, Caller ID, T1 E1 to 2-Wire FXO Drop or Insert, PC to 2-Wire FXO Drop or Insert
- FXS Capabilities
 - Detection of ON hook and OFF hook status
 - Ring and Battery Voltage Generation, Dial Tone Generation
 - Transmit and Capture Traffic (Digits, Tones, and Voice)
 - T1 E1 FXS Drop or Insert, PC to 2-Wire FXS Drop or Insert
- FXO/FXS ports supports termination characteristics for different countries
- Loudspeaker provided to hear the voice being transmitted on FXO/FXS ports
- FAX data transmission and reception over FXO and FXS ports
- Command Line Interface (CLI) based testing of FXO/FXS for automation and remote access

Testbed Setup Configuration

Test Bed setup is provided to establish communication between MAPS™ FXO FXS and the DUT. It includes configuring FXO FXS Line parameters, Ring parameters, Tone parameters, and End user configurations to transmit and receive Signaling and various Traffic types including File, Tones, Digits, and FAX over T1 E1.

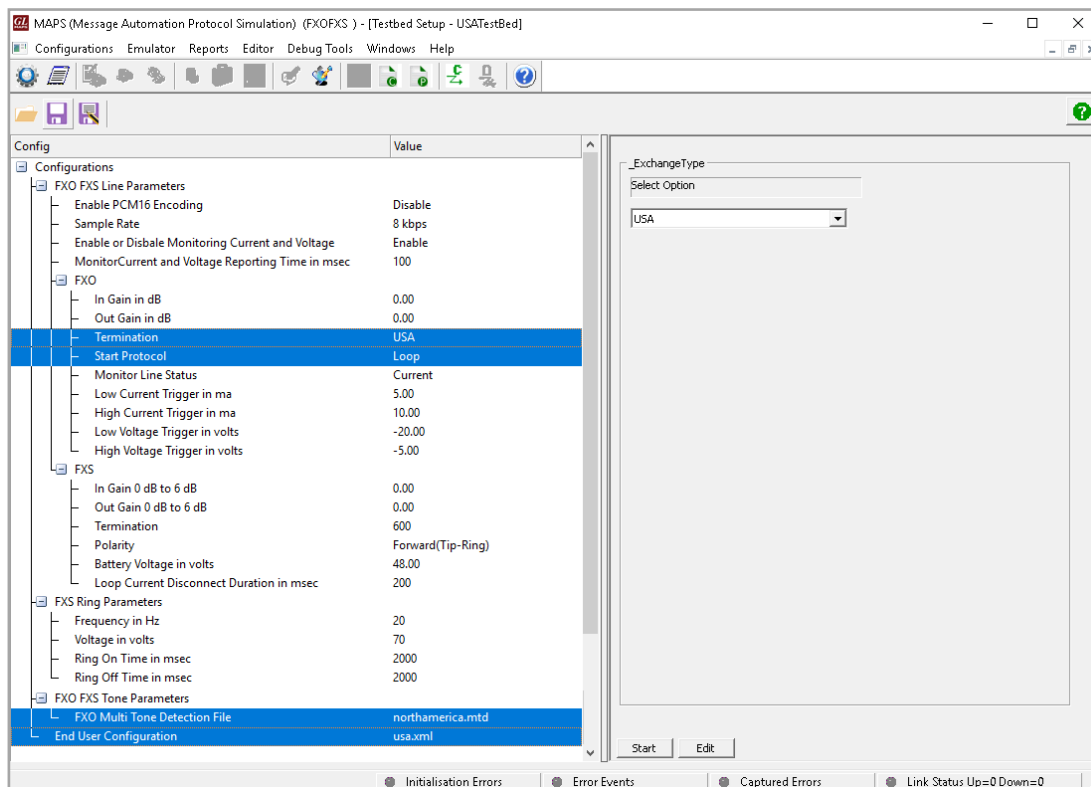

Figure: Tested Setup

Global Configuration

MAPS™ FXO FXS includes Global Configurations used to store a list of common variables that will be applied to all calls (all Scripts which uses the global variables defined by global configurations). Most notably Call Duration, Inter Call Duration, and Call Answer Time. Global Configuration defines a variety of detailed parameters that probably do not require users to change them very frequently.

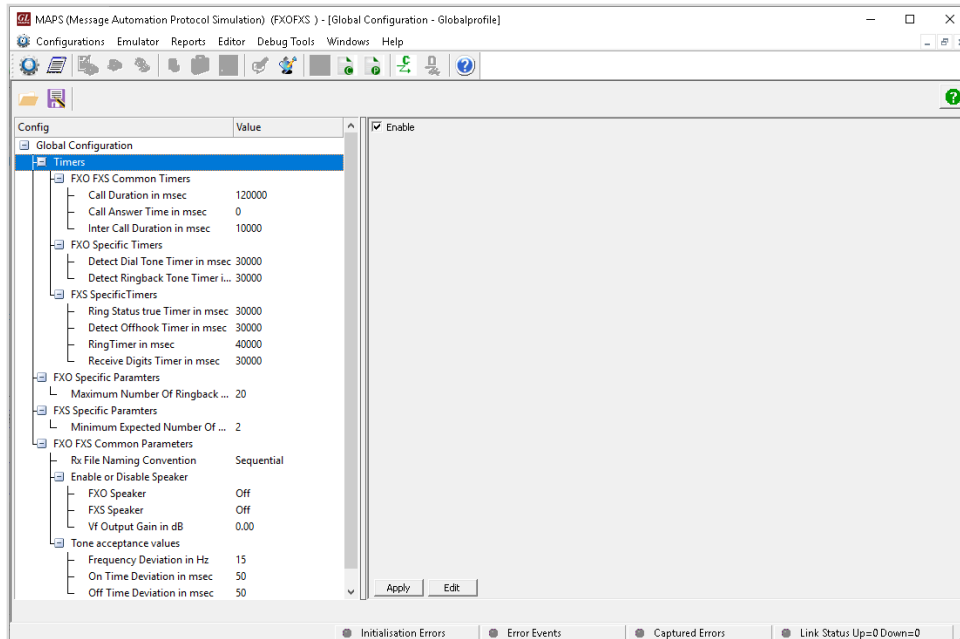

Figure: Global Configuration

Pre-processing Tools

Profile Editor

MAPS™ FXO FXS script editor includes simple language to edit scripts that can define the operations like detecting ON Hook and OFF Hook status, supplies ring voltage, dial tone and battery current. Functions such as Place Call, Answer Call, Tx/Rx Digits, Voice, Tones, Send/Receive FAX are all defined within the script. Additionally, more advanced script may also be defined in the script editor.

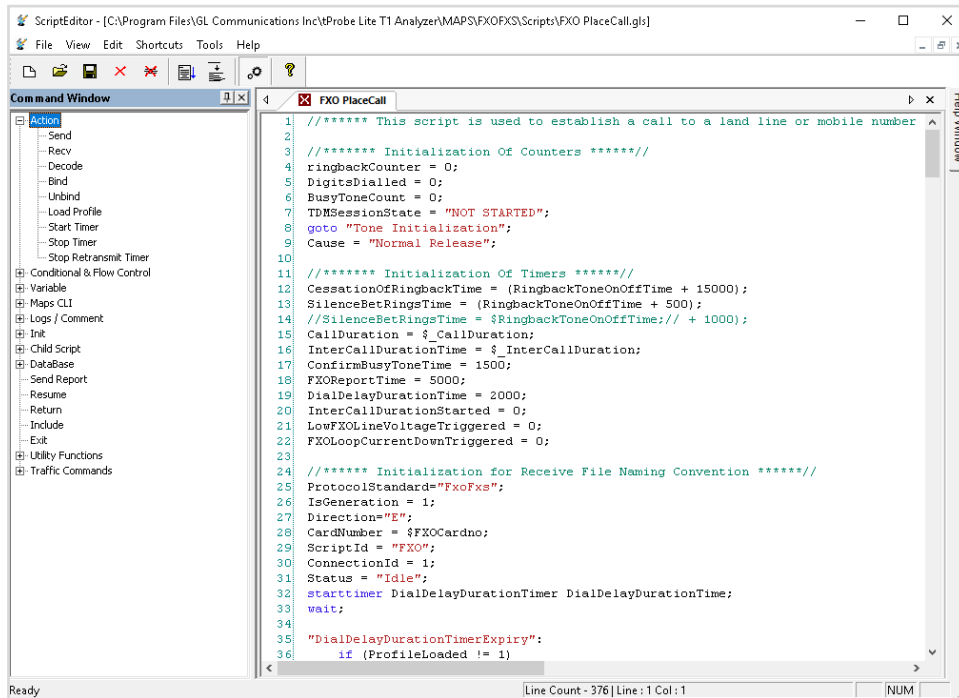

Figure: Script Editor

Profile Editor

This feature allows loading profile to edit the values of the variables using GUI, replacing the original value of the variables defined in the scripts. An XML file defines a set of multiple profiles with varying parameter values that allow users to configure call instances in call generation and to receive calls. Traffic profile to support Automated and User defined Tx Rx File, Tones, Digits, Fax, Dynamic VF, and also IVR and VQT traffic types.

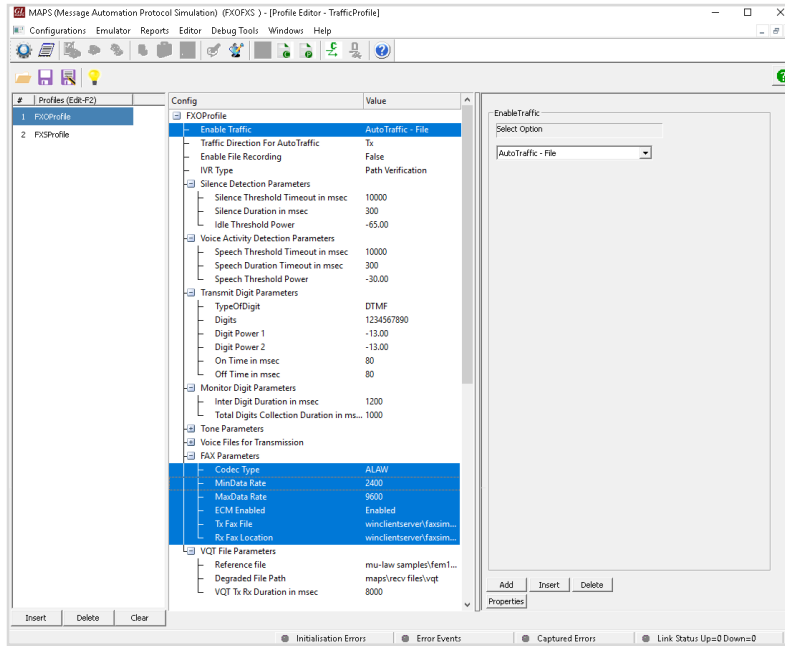
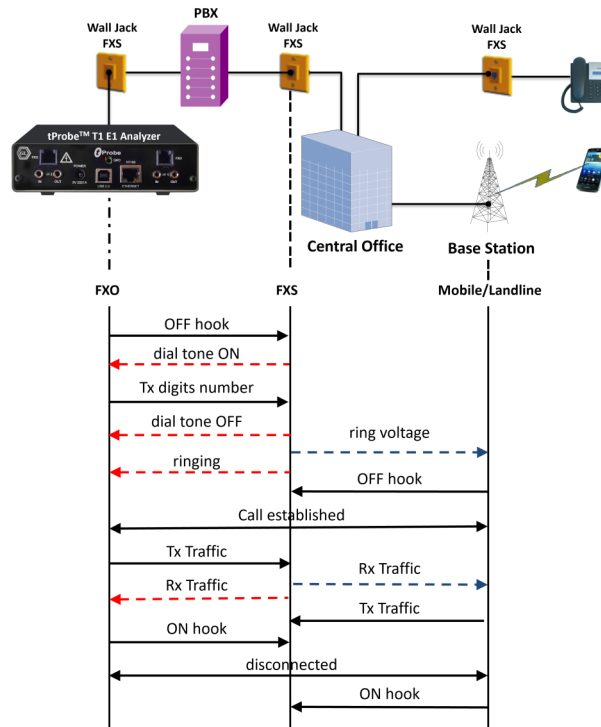

Figure: Profile Editor

FXO Testing Scenarios

Scenario 1: tProbe™ FXO Port to Mobile or Landline Phone (via wall FXS -> Local PBX -> Service provider central office)

The call flow shown here depicts the call from tProbe™ FXO port to the Landline or Mobile phone through the wall jack FXS, local PBX, and central office of the service provider and base station.



FXS Testing Scenarios

Scenario 2: tProbe™ FXS Port to a Regular 2-wire Phone

The call flow shown here depicts the call from tProbe™ FXS port to regular phone (2-wire phone) via RJ-11 cable. Places the ring to regular phone (2-wire phone), captures the incoming traffic into the file and transmits traffic to the other end.

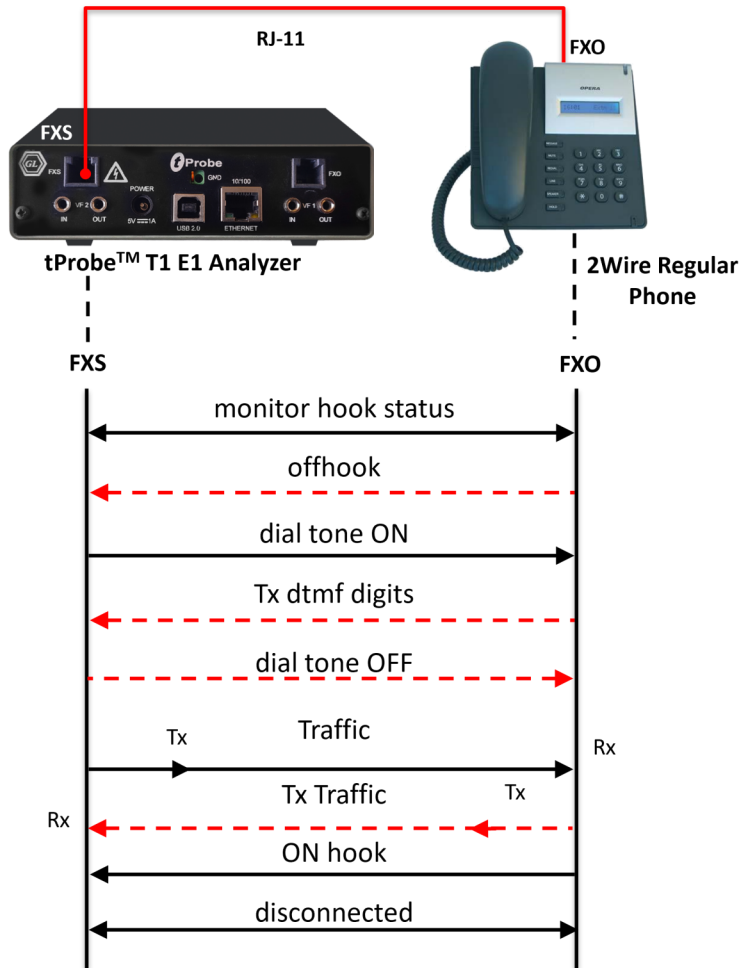

Scenario 3: tProbe™ FXO port to tProbe™ FXO port via Teltone Switch (TLS 3)

It is also possible to establish call from tProbe™ FXO port to another tProbe™ FXO port via a Teltone Switch. Teltone Switch (TLS) provides two FXS ports in it and acts as a local exchange connecting the two lines.

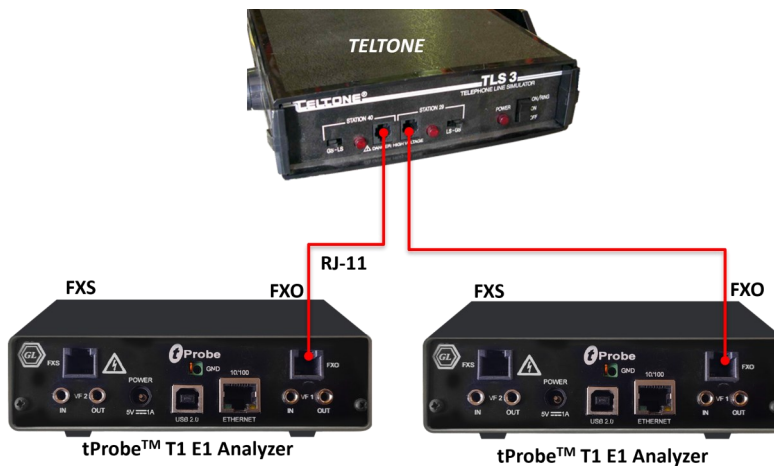

Scenario 4: tProbe™ FXO port to IP via ATA

FXO port is connected to VoIP phone or PC with a local network via an ATA device. The test scenario below depicts the call established between tProbe™ FXO port and VoIP phone via ATA.

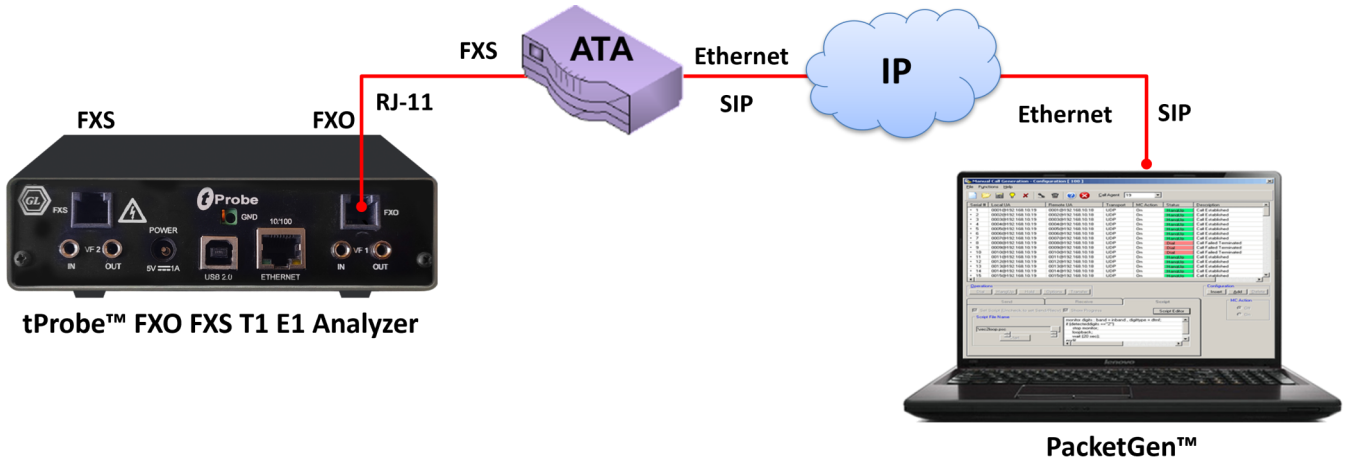

Scenario 5: tProbe™ FXO Port to tProbe™ FXS Port (loopback)

Shown below is the call flow from tProbe™ FXO port to tProbe™ FXS port connected in loopback via RJ-11 cable.

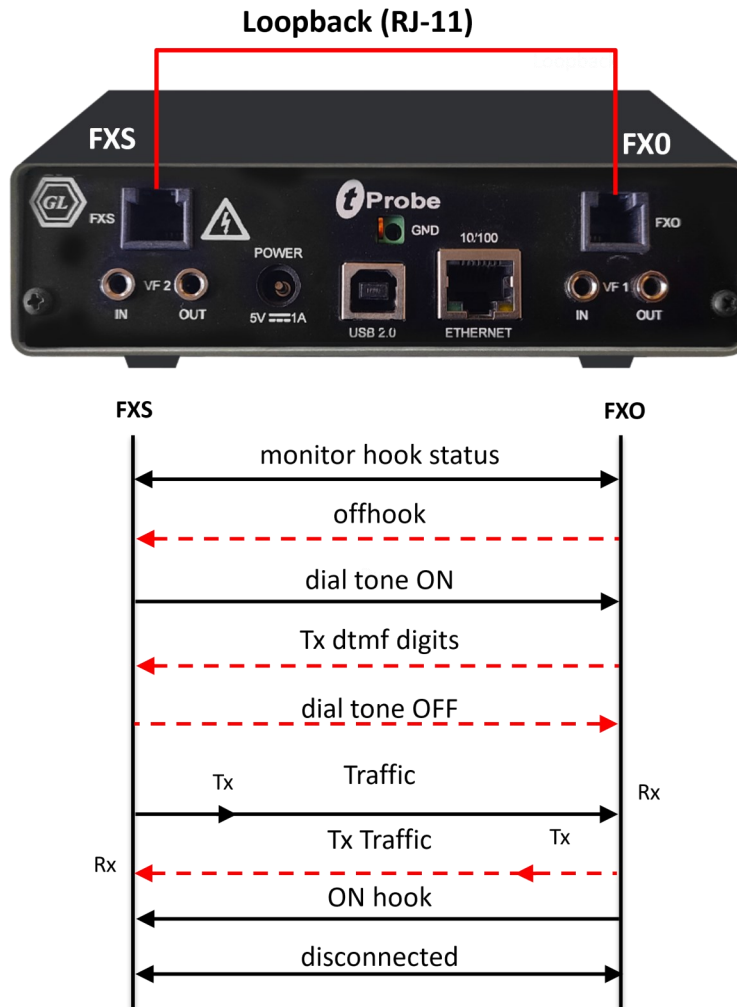

Scenario 6: tProbe™ FXS to FXO port on GL's Dual UTA HD

Shown below is the call flow between tProbe™ FXS port to GL's Dual UTA HD via RJ-11 cable, with dual UTA initiating call.

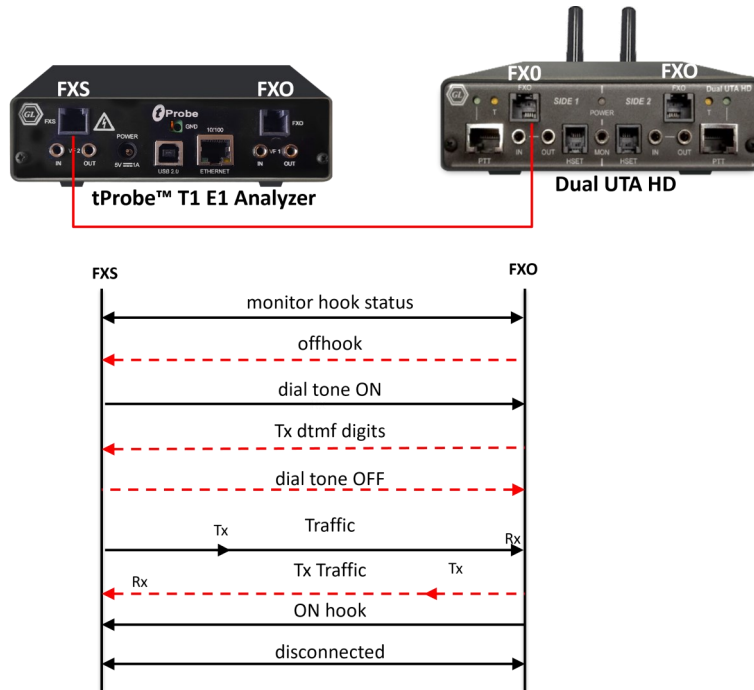

FXO and FXS Testing using tProbe™ Client Server

tProbe™ WCS commands can be used to set up different types of FXO and FXS environment and to perform FXO and FXS specific operations. The FXO and FXS ports on tProbe™ allows to simulate various features using WCS scripting.

The tProbe™ FXS port performs operations like detecting "ON hook" and "OFF hook" status of the FXO device, supplies ring voltage, dial tone ,battery current .The tProbe™ FXS port captures incoming traffic into the file and it can also transmit the traffic like tones, noise and voice files.

```

tProbe FXS to tProbe FXO_E1.gls - GLClient
File Edit View Connect Script Log User Help
Task 3: Task 3 started
tx server file "A-Law Samples\count10.pcm" #2:5 15 sec:// transmitting the traffic on FXS Port
Task 6: Task 6 started
Waiting 20000 msec
Task 5: Tx File: #1: 120000 bytes
Task 5: Task 5 complete
Task 6: Tx File: #2: 120000 bytes
Task 6: Task 6 complete
set fxs signaling onhook #1; // disconnecting call(end the call)
OK
Waiting 2000 msec
Task 3: 200000 bytes written to file 'FXS_capture.ala'
Task 3: Task 3 complete
Task 4: 160000 bytes written to file 'FXO_capture.ala'
Task 4: Task 4 complete
set speaker off #1;
OK
set speaker off #2;
OK
// Line monitoring
get fxs loop current #1; // for safety
#1.current=0.0
get fxs tip-ring voltage #1; // for safety
#1.volt=0.0
end task *; // End all running tasks.
OK
Run complete
Task 1: Task 1 terminated
Task 2: Task 2 terminated

// tProbe FXS to tProbe FXO_E1.gls
// For more information refer to the Section 7.2.3 of user manual.
// Note: This script runs automatically without user intervention, recording the traffic
// being sent on FXO and FXS ports.

// Turn on Inward Driver loopback to allow transmission and reception over FXO and FXS
set inward driver loopback on #*;

set latency 20 msec; // Set the requesting client's transmit latency to 20 ms.
set response 500 msec; // Set the requesting client's response time to 500 ms.

Ready Ver: 4 B NUM
    
```

Figure: FXO and FXS Testing using tProbe™ Client Server

Fax Simulation over Analog Lines

MAPS™ FXO FXS application can be used to send/receive FAX to/from FAX machine over analog lines using tProbe™ FXO /FXS ports. tProbe™ FXO port is connected to telephone exchange via wall jack, while the FAX machine may be connected to one of the other telephone lines of exchange via wall jack. tProbe™ FXS port is directly connected to FAX machine (FXO). This operation also requires T1 E1 ports to be connected in loopback using cross-over cables.

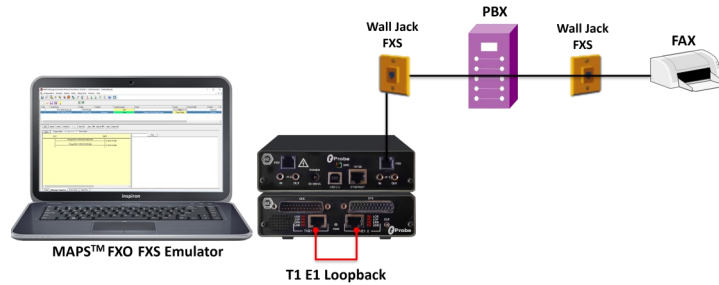

Figure: Send/Receive FAX over FXO Port

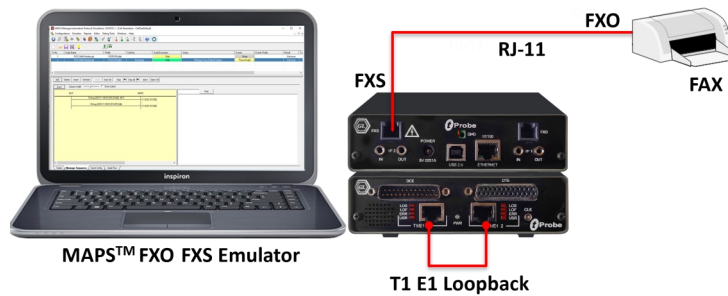

Figure: Send/Receive FAX over FXS Port

FAX Place Call and Answer Call

MAPS™ is configured for the out going signaling and to respond to incoming signals. Tests can be configured to run once, multiple iterations and continuously. Also, allows users to create multiple entries using quick configuration feature. The loaded FXO FXS test scripts for placing and answering calls are manually started.

MAPS™ Reports GUI logs all the captured events including placing call, incoming call, call connection, Tx Rx Traffic captures by each timeslot of each trunk.

Sr No	Script Name	Profile	CallInfo	Script Execution	Status	Events	E	Result	Total Iterations	Completed Iterations
1	FXO Placecall.gls	FXOFSProfile	1,1	Abort	Fax Session Terminated	Disconnect Call		Pass	1	0
2	PXS AnswerCall.gls	FXOFSProfile	2,1	Abort	Fax Session Terminated	Disconnect Call		Pass	1	0
3	PXS Placecall.gls	FXOFSProfile		Start		None				
4	PXO AnswerCall.gls	FXOFSProfile		Start		None				

Date/Time	Captured Events	Call Trace Id	Script Name	Script Id
2014-12-4 16:57:16.993000	FxoBoardCount = 2	GetBoardCount	MonitorCurrent-Voltage.gls	ProtScriptId_24436658-4606-3724
2014-12-4 16:57:21.213000	FxoFxsType = FXSIN_OUT	2,1	PXS AnswerCall.gls	CGProtScriptId_24440240-4607-3616
2014-12-4 16:57:21.213000	FxoFxsType = FXSLODPCUR	2,1	PXS AnswerCall.gls	CGProtScriptId_24440240-4607-3616
2014-12-4 16:57:23.329000	MonitorHiLoopCurrentTaskId = 12	1,1	PXO Placecall.gls	CGProtScriptId_24440958-4608-3616
2014-12-4 16:57:24.940000	Placing the Call	1,1	PXO Placecall.gls	CGProtScriptId_24440958-4608-3616
2014-12-4 16:57:25.067000	FxoFxsType = FXSHOOKSTATUS	2,1	PXS AnswerCall.gls	CGProtScriptId_24440240-4607-3616
2014-12-4 16:57:25.067000	Fxs Hook Status = offhook	2,1	PXS AnswerCall.gls	CGProtScriptId_24440240-4607-3616
2014-12-4 16:57:25.068000	Sending Dial tone	2,1	PXS AnswerCall.gls	CGProtScriptId_24440240-4607-3616
2014-12-4 16:57:26.949000	Monitoring Dial Tone	1,1	PXO Placecall.gls	CGProtScriptId_24440958-4608-3616
2014-12-4 16:57:27.221000	Loop Current = 12.100000	Monitoring In Progress	MonitorCurrent-Voltage.gls	ProtScriptId_24436658-4606-3724
2014-12-4 16:57:27.229000	Fxo Line Voltage = -12.000000	Monitoring In Progress	MonitorCurrent-Voltage.gls	ProtScriptId_24436658-4606-3724
2014-12-4 16:57:27.321000	Loop Current = 12.100000	Monitoring In Progress	MonitorCurrent-Voltage.gls	ProtScriptId_24436658-4606-3724
2014-12-4 16:57:27.331000	Fxo Line Voltage = -11.000000	Monitoring In Progress	MonitorCurrent-Voltage.gls	ProtScriptId_24436658-4606-3724
2014-12-4 16:57:27.423000	Loop Current = 12.100000	Monitoring In Progress	MonitorCurrent-Voltage.gls	ProtScriptId_24436658-4606-3724
2014-12-4 16:57:27.431000	Fxo Line Voltage = -9.000000	Monitoring In Progress	MonitorCurrent-Voltage.gls	ProtScriptId_24436658-4606-3724
2014-12-4 16:57:27.523000	Loop Current = 12.100000	Monitoring In Progress	MonitorCurrent-Voltage.gls	ProtScriptId_24436658-4606-3724
2014-12-4 16:57:27.531000	Fxo Line Voltage = -9.000000	Monitoring In Progress	MonitorCurrent-Voltage.gls	ProtScriptId_24436658-4606-3724
2014-12-4 16:57:27.623000	Fxo Line Voltage = -9.000000	Monitoring In Progress	MonitorCurrent-Voltage.gls	ProtScriptId_24436658-4606-3724
2014-12-4 16:57:27.631000	Loop Current = 12.100000	Monitoring In Progress	MonitorCurrent-Voltage.gls	ProtScriptId_24436658-4606-3724

Figure: Place /Answer Call and Event Log

911 CAMA Signaling Simulation (FXO FXS)

CAMA (Centralized Automatic Message Accounting) is a special analog trunk, originally developed for long-distance billing, but now mainly used for emergency call services (911 and E911 services).

The tProbe™ FXO port can be directly connected to 911 selective router or PSAP on CAMA-type circuits for simulation of CAMA calls to the selective router or PSAP. The script will seize the line, wait for wink, dial ANI and wait for call connect

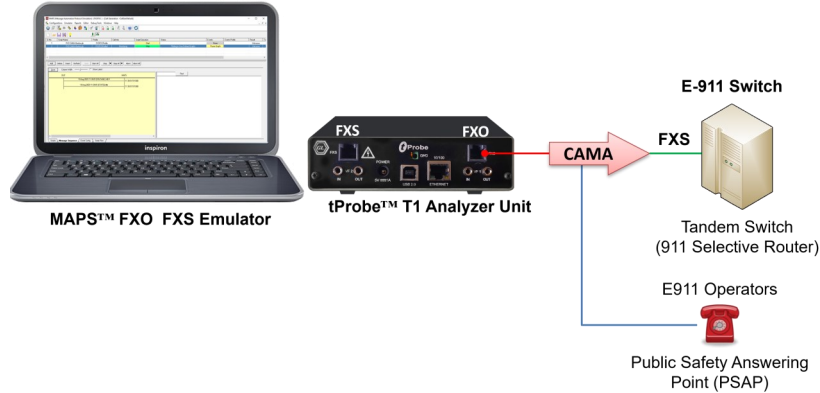

The below image shows tProbe™ FXS port connected to central office or selective router for terminating CAMA calls. The script will detect seizure from far side, provide wink, wait for ANI, and connect the call.

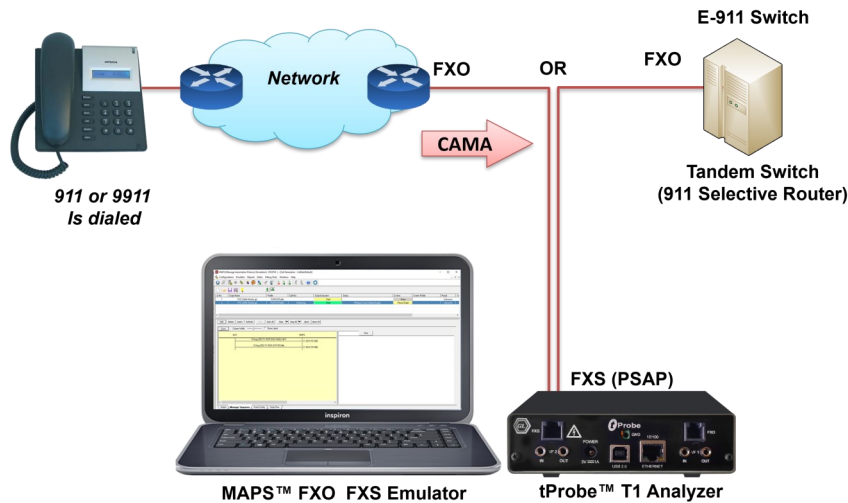

The MAPS™ FXO FXS Emulator application displays a real-time signaling sequence of the CAMA type trunk connected to the 911 Selective Route as shown below

The screenshot shows the MAPS (Message Automation Protocol Simulation) (FXOFXS) application interface. The main window displays a table with the following data:

Sr No	Script Name	Profile	Call Info	Script Execution	Status	Events	E Result	Total Iterations	Completed Iterations
1	FXO CAMA Originating.gls	FXO/FXS/Profile	ANI 3015551234	Stop	Call Connected	Terminate Call	Unknown	1	0
2	FXS CAMA Terminating.gls	FXO/FXS/Profile	ANI 3015551234	Stop	Call Connected	Terminate Call	Unknown	1	0

Below the table, there is a section for "Message Sequence" showing a timeline of events between MAPS and DUT:

Event	Time
Seize	12:02:08.282.1709
Wink (~273 msec)	12:02:08.178.2367
KP 3015551234 ST2P	12:02:08.328.3444
Ringback Tone	12:02:13.11.3096
Offhook	12:02:16.161.6435

911 CAMA FXO Monitoring

The tProbe™ FXO port can be tapped onto CAMA-type circuits for non-intrusive monitoring of 911 service. Monitoring capabilities include Seizure and Wink Start detection, ON Hook and OFF Hook detection and MF digit (calling party ANI) detection. A normal analog call is routed based on the destination (called party) phone number. However, 911 calls are routed based on the calling party number.

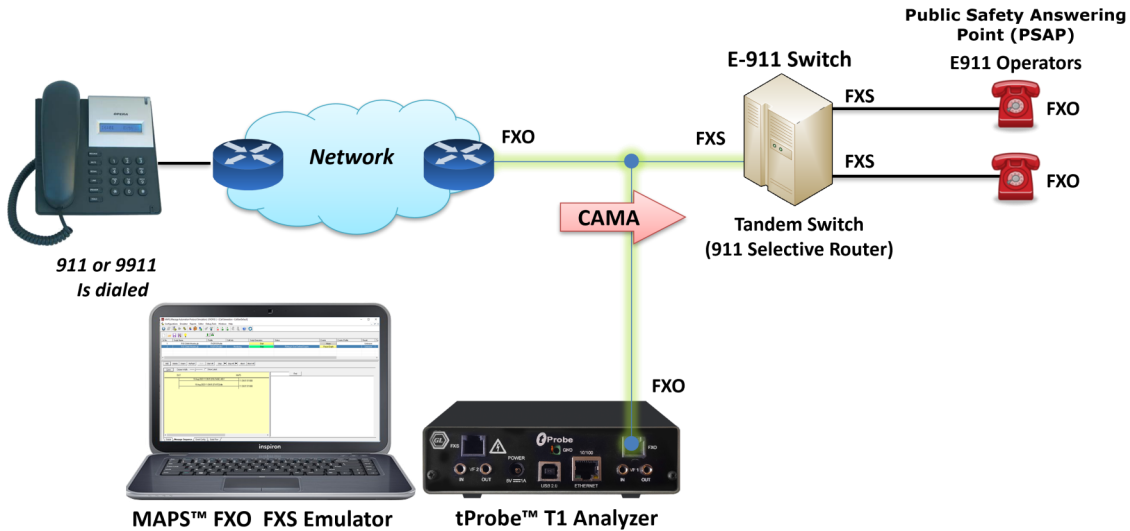

MAPS™ FXO FXS Emulator displaying a real-time ladder diagram of the CAMA type trunk signaling sequence as captured by the FXO port. Typically, there are 5 CAMA signaling types based on the number of digits in ANI, these include, 7-digit transmission (kp-0-nxx-xxxx-st), 8-digit transmission (KP-npd-nxx-xxxx-st), 10-digit transmission (kp-0-npa-nxx-xxxx-st), 20-digit transmission (kp-0-npa-nxx-xxxx-st-kp-yyy-yyy-yyyy-st), and kp-2-st (indicates a failure to receive ANI).

The below screenshot depicts monitoring a 10-digit ANI transmission using MAPS™ FXO FXS Emulator. Continuously monitor line current and voltages of FXO and FXS ports and plots the detected line voltage in user-defined graphs.

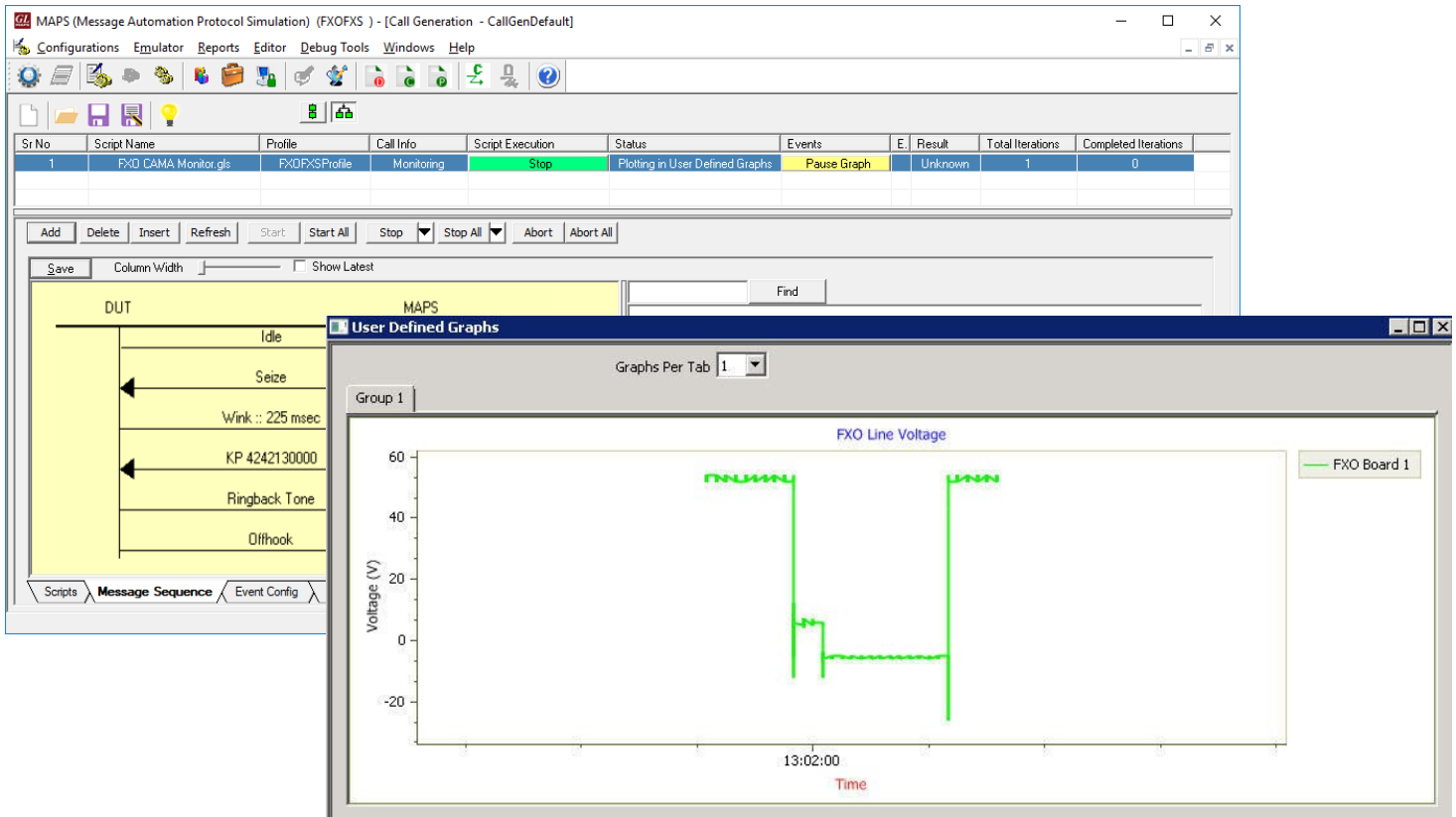

Buyer's Guide

Item No	Product Description
XX624	MAPS™ FXO FXS (requires PTE015)
PTE015	w/ 2Wire FXO and FXS Optional Board
PTE001	tProbe™ T1 E1 Base Unit
XX651	MAPS™ CAS Emulator
PKS170	CLI Support for MAPS™

For more information, refer to [Automated Analog Terminal \(FXO\) and Network Port \(FXS\) Testing](#) webpage.



GL Communications Inc.

818 West Diamond Avenue - Third Floor, Gaithersburg, MD 20878, U.S.A

(Web) www.gl.com - (V) +1-301-670-4784 (F) +1-301-670-9187 - (E-Mail) info@gl.com